

# 300 REMINGTON ULTRA MAGNUM (RUM)

## Test Specifications:

Firearm Used: Universal

Barrel Length: 24"

Twist: 1-10"

## Components:

Case: Nosler

Trim-to Length: 2.840"

Primer: WLRM

## Remarks:



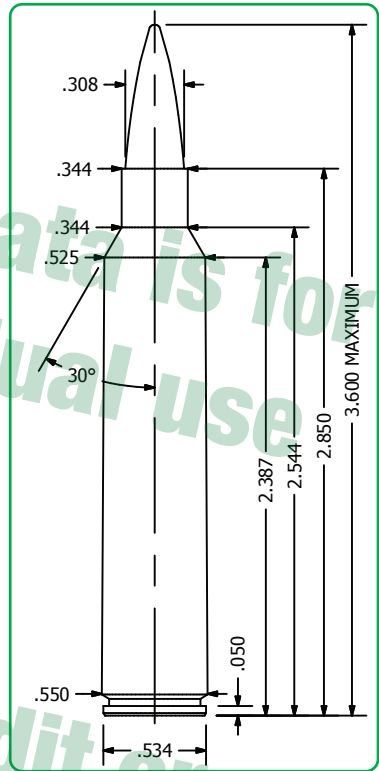

Remington took a bold step with their 1999 introduction of the 300 Ultra Mag. The cartridge represents a departure from the conventional wisdom that a magnum cartridge requires a belted case. They don't. Belted or not, the 300 RUM is a magnum by any definition. It offers the long-range hunter a devastating combination of power and flat trajectory exceeded by few other cartridges. Based on a slightly modified 404 Jeffrey case, the Remington version uses a rebated rim. Headspace is accomplished in the same manner as a conventional rimless case — that is, stopping on the shoulder. The Remington team did an admirable job turning out a potent and thoroughly modern design.

There are a few caveats when considering such a specialized round. Action length and recoil are the most obvious. With the current rush toward short actions, the 300 RUM requires a full-size action. Remington obviously considered this angle when they introduced their new series of Short Action Ultra Mag (SAUM) cartridges a year or two later. Given its case capacity and bore size, the powders capable of exploiting the cartridges' true potential is continuing to improve. Bullet selection is critical with high performance cartridges, and the 300 RUM is no exception. Projectiles that perform reliably on big game at lesser velocities can become varmint bullets at speeds delivered by the 300 RUM. This is particularly true of those weighing 150 grains or less. In a standard weight hunting rifle, the 300 RUM can be quite punishing to the average shooter. Barrel life, while less a consideration on a hunting rifle than a target gun, is also diminished. These comments apply equally to any of the cartridges similar in capacity or performance to the 300 RUM.

Despite these considerations, the 300 RUM provides Remington with a real contender in the arena of 30 caliber heavyweights. It fills a highly specialized niche in the hunting fields quite well. With all it has going for it, this powerhouse should have a successful future.



# 300 REMINGTON ULTRA MAGNUM (RUM)

	Bullet	Caliber	Weight	Type	C.O.A.L.
	#2145	.308"	165gr.	SBT	3.600"
	#2140	.308"	165gr.	HPBT	3.600"
	#4665	.308"	165gr.	TGK	3.600"
	#2200	.308"	168gr.	HPBT Match	3.600"
	#7768	.308"	168gr.	TMK Match	3.740"







Powder	Velocity	2900	3000	3100	3150	3200	3250	3300
H4350					79.6	81.7		
Hybrid 100V				78.5	80.3			
Hunter	74.0	76.3	78.6					
H4831sc		86.7	88.2	89.0	89.8			
IMR 4955 End.			82.8	84.4	85.9			
RE 22				84.1	85.5	86.8		
N165				86.8	88.6			
IMR 7828ssc				84.9	85.9	87.0	88.0	
RE 25		85.7	89.3	90.9	92.5	94.1	95.5	
IMR 7977 End.		87.6	90.3	91.7	93.3	94.9		
H1000			88.3	90.2	92.0	93.6		
Magnum			89.1	90.9	92.8	95.0		
Retumbo		88.2	91.0	92.5	94.0	95.5		
RE 33		96.8	99.9	101.3	102.8	104.1	105.4	
<b>Energy Ft. Lbs</b>		<b>3081</b>	<b>3297</b>	<b>3520</b>	<b>3635</b>	<b>3751</b>	<b>3869</b>	<b>3989</b>

Special Load	Powder	Grains	Velocity fps	Energy Ft. lb
<b>Accuracy Load</b>	RE 33	105.4	3300	3989
<b>Hunting Load</b>	RE 25	95.5	3300	3989

*Sierra does not recommend MatchKing bullets for hunting applications.*

# 300 REMINGTON ULTRA MAGNUM (RUM)

Bullet	Caliber	Weight	Type	C.O.A.L.
	#2275	.308"	175gr. HPBT Match	3.730"
	#7775	.308"	175gr. TMK Match	3.750"
	#2150	.308"	180gr. SPT	3.600"
	#2160	.308"	180gr. SBT	3.600"
	#2220	.308"	180gr. HPBT Match	3.740"
	#2170	.308"	180gr. RN	3.550"



Powder	Velocity	2800	2900	3000	3050	3100	3150	3200
H4350	70.1	73.8	77.3	78.9				
H4831sc		79.3	82.7	84.2				
RE 22		77.9	81.1	82.6	84.2			
N165	76.7	80.6	84.0					
IMR 7828ssc		80.2	83.5	84.9	86.3			
RE 25			87.0	88.7	90.3	92.0		
IMR 7977 End.		87.6	90.8	92.4	93.9	95.4		
H1000			85.3	87.6	89.9	92.0		
Magnum			86.6	88.5	90.6			
RE 33			96.9	98.5	100.1	101.6	103.1	
<b>Energy Ft. Lbs</b>		<b>3046</b>	<b>3267</b>	<b>3497</b>	<b>3614</b>	<b>3734</b>	<b>3855</b>	<b>3978</b>



Special Load	Powder	Grains	Velocity fps	Energy Ft. lb
<b>Accuracy Load</b>	IMR 7828ssc	86.3	3100	3734
<b>Hunting Load</b>	RE 33	103.1	3200	3978

*Sierra does not recommend MatchKing bullets for hunting applications.*

# 300 REMINGTON ULTRA MAGNUM (RUM)

	Bullet	Caliber	Weight	Type	C.O.A.L.				
	#2210	.308"	190gr.	HPBT Match	3.740"				
	#7795	.308"	195gr.	TMK Match	3.870"*				
*requires 1 x 10" twist or faster twist									
Powder	Velocity	2800	2850	2900	2950	3000	3050	3100	
RE 22		75.0	76.7	78.3	79.9	81.5			
N165		75.5	77.4	79.3	81.1				
IMR 7828ssc		76.0	77.4	78.9	80.5	82.2			
RE 25		82.0	83.4	84.9	86.5	88.3	90.2		
IMR 7977 End.		83.1	84.8	86.3	87.9	89.3	90.7		
H1000					83.1	85.9	88.2	89.8	
Magnum		80.1	81.7	83.4	85.1	86.8	88.6		
Retumbo			83.6	85.2	86.7	88.3	89.9	91.5	
RE 33		90.8	92.5	94.1	95.6	97.0	98.4	99.8	
<b>Energy Ft. Lbs</b>		<b>3307</b>	<b>3426</b>	<b>3547</b>	<b>3671</b>	<b>3796</b>	<b>3924</b>	<b>4054</b>	
Special Load	Powder	Grains	Velocity fps	Energy Ft. lb					
<b>Accuracy Load</b>	IMR 7828ssc	82.2	3000	3796					
<i>Sierra does not recommend MatchKing bullets for hunting applications.</i>									

# 300 REMINGTON ULTRA MAGNUM (RUM)



		Bullet	Caliber	Weight	Type					C.O.A.L.
	#2165	.308"	200gr.	SBT					3.600"	
	#2230	.308"	200gr.	HPBT Match					3.780"	
	#2231	.308"	200gr.	HPBT Match					4.060"*	
*requires 1 x 9" twist or faster twist										
Powder	Velocity	2650	2750	2800	2850	2900	2950	3000		
RE 22			75.1	76.5	78.2	79.9	81.8			
N165	74.5	78.4	80.2	81.9	83.6					
IMR 7828ssc		77.5	79.1	80.8	82.6	84.5				
RE 25		80.9	82.5	84.1	85.8	87.6	89.5			
IMR 7977 End.		83.6	85.0	86.4	88.0	89.6	91.2			
H1000			80.8	82.5	84.3	86.3	88.4			
Magnum		80.1	82.5	84.7	86.7	88.6				
Retumbo					82.6	84.8	86.7	88.2		
RE 33		90.2	91.8	93.4	95.0	96.7	98.3			
IMR 8133		87.0	88.8	90.5	92.1	93.6	95.1			
US869			96.5	98.5	100.5	102.4	104.3			
<b>Energy Ft. Lbs</b>		<b>3118</b>	<b>3358</b>	<b>3481</b>	<b>3607</b>	<b>3734</b>	<b>3864</b>	<b>3996</b>		
Special Load	Powder	Grains	Velocity fps	Energy Ft. lb						
Accuracy Load	Magnum	88.6	2950	3864						
Hunting Load	RE 25	89.5	3000	3996						
<i>Sierra does not recommend MatchKing bullets for hunting applications.</i>										

**300 REMINGTON ULTRA MAGNUM (RUM)**

Bullet		Caliber	Weight	Type	C.O.A.L.					
		#9240	.308"	210gr.	HPBT Match	3.820"*				
<i>*requires 1 x 10" twist or faster twist</i>										
Powder	Velocity	2600	2650	2700	2750	2800	2850	2900		
IMR 7828ssc		70.9	72.8	74.6	76.5	78.4	80.3			
RE 25		74.9	76.5	78.1	79.6	81.2	82.8	84.4		
IMR 7977 End.		77.3	78.9	80.4	82.0	83.5	85.1	86.6		
H1000		70.8	72.9	74.9	77.0	79.0	81.0	83.1		
Magnum		78.7	79.8	80.8	81.9	83.0				
Retumbo		74.9	76.6	78.4	80.2	81.9	83.7	85.4		
IMR 8133		81.5	83.1	84.6	86.2	87.8	89.4	90.9		
US869		86.9	88.9	90.9	93.0	95.0	97.1	99.1		
<b>Energy Ft. Lbs</b>		<b>3152</b>	<b>3274</b>	<b>3399</b>	<b>3526</b>	<b>3655</b>	<b>3787</b>	<b>3921</b>		
Special Load	Powder	Grains	Velocity fps	Energy Ft. lb						
<b>Accuracy Load</b>	IMR 7977 End.	86.6	2900	3921						
<i>Sierra does not recommend MatchKing bullets for hunting applications.</i>										

Do not edit or  
redistribute.

# 300 REMINGTON ULTRA MAGNUM (RUM)

Bullet	Caliber	Weight	Type	C.O.A.L.				
	#2240	.308"	220gr. HPBT Match	3.750"*				
	#2180	.308"	220gr. RN	3.550"				
*requires 1 x 10" twist or faster twist								
Powder ▾	Velocity >	2550	2650	2700	2750	2800	2850	2900
N165		74.3	77.9	79.9	82.0			
IMR 7828ssc			76.3	77.9	79.6	81.3		
RE 25			79.5	81.2	82.9	84.6	86.3	
IMR 7977 End.			82.3	84.1	85.8	87.4		
H1000			76.4	78.0	79.8	81.9	84.1	
Magnum			80.3	82.2	84.0	85.7		
Retumbo			80.3	82.2	84.0	85.7	87.4	
RE 33			90.5	92.1	93.7	95.2	96.7	98.1
IMR 8133			85.8	87.5	89.0	90.5	91.9	
US869				94.8	96.9	98.9	100.8	102.7
<b>Energy Ft. Lbs</b>		<b>3176</b>	<b>3430</b>	<b>3561</b>	<b>3694</b>	<b>3829</b>	<b>3967</b>	<b>4108</b>
Special Load	Powder	Grains	Velocity fps	Energy Ft. lb				
<b>Accuracy Load</b>	N165	82.0	2750	3694				
<b>Hunting Load</b>	RE 33	98.1	2900	4108				
<i>Sierra does not recommend MatchKing bullets for hunting applications.</i>								

**300 REMINGTON ULTRA MAGNUM (RUM)**

Bullet		Caliber	Weight	Type	C.O.A.L.					
		#2251	.308"	230gr.	HPBT Match	4.070"*				
*requires 1 x 8" twist or faster twist										
Powder	Velocity	2500	2600	2700	2750	2800	2850	2900		
N165		72.9	76.7	80.6						
RE 23			73.6	77.1	78.8					
RE 25			78.6	81.5	83.1	84.7	86.4			
IMR 7977 End.			80.7	84.3	85.8	87.2				
H1000			76.6	80.7	82.6	84.4				
Retumbo			78.8	82.0	83.7	85.5				
RE 33			87.1	90.5	92.0	93.5	94.8	96.1		
IMR 8133			83.6	87.1	88.7	90.1				
US869				93.9	95.7	97.5	99.2			
<b>Energy Ft. Lbs</b>		<b>3191</b>	<b>3452</b>	<b>3722</b>	<b>3862</b>	<b>4003</b>	<b>4147</b>	<b>4294</b>		
Special Load	Powder	Grains	Velocity fps	Energy Ft. lb						
<b>Accuracy Load</b>	RE 23	78.8	2750	3862						
<i>Sierra does not recommend MatchKing bullets for hunting applications.</i>										



# 300 REMINGTON ULTRA MAGNUM (RUM)

Bullet	Caliber	Weight	Type	C.O.A.L.							
	#9245	.308"	240gr.	HPBT Match	3.780"*						
<i>*requires 1 x 9" twist or faster twist</i>											
Powder	Velocity	2350	2450	2550	2650	2700	2750	2800			
N165	67.2	70.7	74.6								
RE 23	67.9	72.1	76.2								
RE 25		75.8	79.2	80.9	82.7						
IMR 7977 End.	74.9	79.1	83.3	85.4							
H1000		74.9	78.9	80.7							
Retumbo		75.8	79.6	81.4							
RE 33		82.4	86.3	88.1	89.7						
US869		87.9	91.1	92.8	94.5	96.3					
<b>Energy Ft. Lbs</b>		<b>2942</b>	<b>3198</b>	<b>3465</b>	<b>3742</b>	<b>3884</b>	<b>4029</b>	<b>4177</b>			
Special Load	Powder	Grains	Velocity fps	Energy Ft. lb							
<b>Accuracy Load</b>	N165	74.6	2550	3465							
<i>Sierra does not recommend MatchKing bullets for hunting applications.</i>											

*Do not edit or redistribute.*