

300 REMINGTON SHORT ACTION ULTRA MAG

Test Specifications:

Firearm Used: Universal

Barrel Length: 24"

Twist: 1-10"

Components:

Case: Nosler

Trim-to Length: 2.005"

Primer: WLRM



Remarks: Coming close on the heels of their larger brothers, the Short Action Ultra Mags are Remington's response to Winchester's WSM series of cartridges. Acknowledging the demand for potent, fast-handling, and light-weight hunting rifles, Remington introduced their 300 SAUM in the popular Model Seven Magnum. Delivering performance similar to that of the vaunted 300 Win. Mag., it holds a lot of power in an attractive, easy-to-handle package. Like several

other new cartridges, the SAUMs follow the short-fat format of case design. Based on competitive benchrest shooters' experience with the PPC cartridge, this configuration has proven to provide accuracy potential. Perhaps more importantly, it allows the use of a short action. Like the longer RUM case, the SAUM also lacks a belt, a step in the right direction as far as most handloaders are concerned. It features the slightly rebated rim design of the parent case. Like other conventional rimless designs, headspacing is accomplished via the case shoulder.

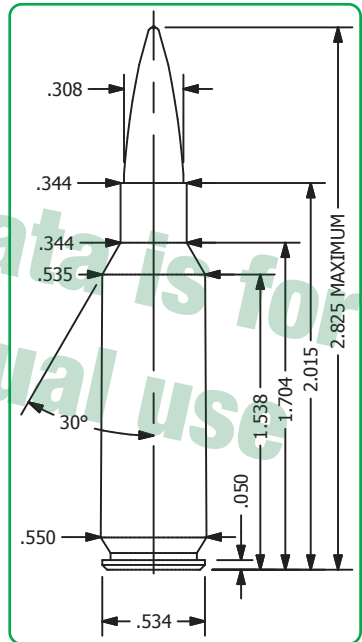
With the similarities between the SAUM and WSM series of cartridges, most general reloading comments apply equally to both. Like the WSM, the 300 SAUM is at its best, and most efficient with bullets running from 150 to 180 grains in weight. For varmint hunters and thin skinned game, the TMK line will add even more to this efficient little cartridge. The addition of the Sierra .30 caliber 165 Game Changer will make this caliber even more effective. Heavier (or more precisely, longer) bullets will intrude on the powder space, thus reducing capacity and velocity. Again, considering the range of game that this combination is intended for, this should not prove to be a major problem. At this point, the choice between WSM and SAUM cartridges of the same bore size pretty much comes down to which flavor the shooter likes better. Those who prefer the Model 70 will go with the WSM, while devotees of the Remington actions will favor the SAUM. Both cartridges should prove to be perfectly suited to their intended uses, with neither offering any real advantage over the other. Such comparisons make perfect grist for the countless campfire and cracker barrel debates that are sure to develop wherever shooters gather. And what's wrong with that?





300 REMINGTON SHORT ACTION ULTRA MAG

Bullet		Caliber	Weight	Type	C.O.A.L.			
	#2100	.308"	110gr.	RN	3.140"			
	#2110	.308"	110gr.	HP	3.240"			



Powder	Velocity	3000	3100	3200	3300	3400	3500	3600
H4895		50.6	52.4	54.2	56.1	58.0	59.9	
IMR 4166 End.		51.5	53.4	55.2	57.0	58.8		
RE 15		53.7	55.8	57.8	59.6	61.2	62.6	
Varget		53.9	56.2	58.3	60.2	62.0		
Big Game		58.4	60.6	63.0	65.6			
N540		54.7	56.6	58.4	60.0	61.6		
IMR 4350		58.3	60.3	62.4	64.5			
IMR 4451 End.		59.4	61.5	63.5	65.3			
RE 17		58.3	60.1	61.8	63.5	65.0	66.5	
Energy Ft. Lbs		2198	2347	2501	2659	2823	2992	3165

Special Load	Powder	Grains	Velocity fps	Energy Ft. lb
Accuracy Load	RE 15	62.6	3600	3165
Hunting Load	H4895	59.9	3600	3165

300 REMINGTON SHORT ACTION ULTRA MAG

	Bullet	Caliber	Weight	Type	C.O.A.L.			
	#2120	.308"	125gr.	SPT	2.700"			
	#2121	.308"	125gr.	HP Match	2.850"			
	#7725	.308"	125gr.	TMK Match	2.850"			
Powder	Velocity	2950	3050	3150	3250	3300	3350	3400
H4895			52.1	53.5	55.0	55.9	56.8	57.7
IMR 4166 End.			51.6	53.3	55.1	56.1	57.1	
RE 15	52.0	54.2	56.2	58.0	58.8	59.5	60.2	
Varget		53.0	54.9	56.8	57.8	58.7	59.6	
Big Game			59.2	61.3	62.5	63.8	65.2	
N540	53.4	55.3	57.0	58.6	59.4	60.1	60.7	
IMR 4350		58.2	60.0	62.0	64.3	65.6		
IMR 4451 End.		58.6	60.3	62.1	64.2	65.3		
H4350		59.8	62.0	64.2	65.4	66.5		
RE 17		58.1	59.6	61.2	62.7	63.5	64.3	65.2
Energy Ft. Lbs		2415	2582	2754	2931	3022	3114	3208
Special Load	Powder	Grains	Velocity fps	Energy Ft. lb				
Accuracy Load	IMR 4166 End.	57.1	3350	3114				
Hunting Load	H4895	57.7	3400	3208				
<i>Sierra does not recommend MatchKing bullets for hunting applications.</i>								

300 REMINGTON SHORT ACTION ULTRA MAG









Bullet	Caliber	Weight	Type	C.O.A.L.
	#2123	.308"	135gr. HPBT Match	2.825"
	#2124	.308"	135gr. HP	2.710"

Powder	Velocity	2800	2900	3000	3100	3200	3300
H4895				49.5	51.6	53.9	56.5
IMR 4166 End.	48.3	50.0	51.7	53.5	55.4		
RE 15		50.4	53.3	55.8	57.8	59.3	
Varget		51.3	52.8	54.4	56.2	58.2	
Big Game			56.6	58.7	60.9	63.4	
N540			54.2	55.9	57.6	59.4	
IMR 4350	55.0	57.2	59.4	61.5	63.6		
IMR 4451 End.			59.4	61.2	63.2	65.3	
H4350			58.3	60.5	62.7	64.9	
RE 17		57.1	59.0	60.7	62.3	63.8	
Energy Ft. Lbs		2350	2521	2697	2880	3069	3264

Special Load	Powder	Grains	Velocity fps	Energy Ft. lb
Accuracy Load	IMR 4451 End.	65.3	3300	3264
Hunting Load	H4895	56.5	3300	3264

Sierra does not recommend MatchKing bullets for hunting applications.

300 REMINGTON SHORT ACTION ULTRA MAG





	Bullet	Caliber	Weight	Type	C.O.A.L.
	#2115	.308"	150gr.	FMJBT	2.780"
	#2130	.308"	150gr.	SPT	2.825"
	#2125	.308"	150gr.	SBT	2.825"
	#2190	.308"	150gr.	HPBT Match	2.825"
	#2135	.308"	150gr.	RN	2.525"
	#2155	.308"	155gr.	HPBT Match	2.825"
	#2156	.308"	155gr.	HPBT Match Palma	2.825"
	#7755	.308"	155gr.	TMK Match	2.900"

Powder	Velocity	2650	2750	2850	2950	3000	3050	3100
H4895			48.1	50.1	52.0	52.9	53.8	
IMR 4166 End.			48.7	50.4	52.0	52.7	53.4	
RE 15			50.0	52.2	54.3	55.2	56.1	57.0
Varget			48.0	50.0	52.2	53.4	54.6	56.0
Big Game			53.5	55.1	57.0	58.1	59.4	60.7
N540			50.0	52.1	54.2	55.3	56.3	57.3
IMR 4350			55.6	57.7	59.7	60.7	61.8	
IMR 4451 End.			55.8	57.9	59.9	60.9	61.9	62.9
H4350				57.0	59.2	60.2	61.3	62.3
RE 16		53.0	54.9	56.8	58.8	59.8	60.8	61.9
RE 17		53.4	55.1	56.8	58.5	59.3	60.2	61.0
Energy Ft. Lbs		2339	2518	2705	2898	2997	3098	3200

Special Load	Powder	Grains	Velocity fps	Energy Ft. lb
Accuracy Load	Big Game	60.7	3100	3200
Hunting Load	RE 15	57.0	3100	3200

Sierra does not recommend MatchKing bullets for hunting applications.

300 REMINGTON SHORT ACTION ULTRA MAG







Bullet	Caliber	Weight	Type	C.O.A.L.
	#2145	.308"	165gr. SBT	2.825"
	#2140	.308"	165gr. HPBT	2.725"
	#4665	.308"	165gr. TKG	2.825"
	#2200	.308"	168gr. HPBT Match	2.825"
	#7768	.308"	168gr. TMK Match	2.900"

Powder	Velocity	2650	2750	2800	2850	2900	2950	3000
H4895		46.8	48.7	49.7	50.7	51.7	52.8	
IMR 4166 End.		46.9	49.0	50.0	51.0	51.8	52.7	
RE 15			51.0	52.3	53.5	54.6	55.6	56.5
Varget		47.2	49.3	50.4	51.5	52.7	54.0	
Big Game			53.3	54.6	55.9	57.2	58.6	59.9
N540			51.2	52.3	53.4	54.5	55.5	56.4
IMR 4350		53.5	56.1	57.3	58.4	59.3	60.2	
IMR 4451 End.			56.1	57.2	58.3	59.3	60.3	61.3
RE 16			55.2	56.2	57.2	58.2	59.1	60.1
RE 17		53.4	55.6	56.6	57.5	58.3	59.1	59.7
H4831sc			59.4	60.4	61.6	62.8	64.1	65.4
Energy Ft. Lbs		2572	2770	2872	2975	3081	3188	3297

Special Load	Powder	Grains	Velocity fps	Energy Ft. lb
Accuracy Load	RE 16	60.1	3000	3297
Hunting Load	RE 15	56.5	3000	3297

Sierra does not recommend MatchKing bullets for hunting applications.

300 REMINGTON SHORT ACTION ULTRA MAG



Bullet	Caliber	Weight	Type	C.O.A.L.
	#2275	.308"	175gr. HPBT Match	2.825"
	#7775	.308"	175gr. TMK Match	2.900"
	#2150	.308"	180gr. SPT	2.825"
	#2160	.308"	180gr. SBT	2.825"
	#2170	.308"	180gr. RN	2.700"
	#2220	.308"	180gr. HPBT Match	2.825"

Powder	Velocity	2450	2550	2650	2750	2800	2850	2900
H4895			45.6	47.4	49.7	51.0		
IMR 4166 End.			45.8	48.1	50.3	51.4		
RE 15				49.9	52.4	53.5	54.5	
Varget			46.6	48.9	51.3	52.5	53.7	
Big Game				53.1	55.6	56.8	57.8	
IMR 4350	51.3	53.4	55.5	57.5	58.6	59.6		
IMR 4451 End.		53.2	55.3	57.4	58.5	59.6	60.7	
H4350			54.3	56.9	58.0	59.1	60.2	
RE 16		52.1	54.0	56.1	57.1	58.2	59.3	
RE 17		51.6	53.6	55.5	56.5	57.3	58.2	
H4831sc			58.8	61.0	62.1	63.1		
Energy Ft. Lbs		2332	2526	2728	2938	3046	3156	3267

Special Load	Powder	Grains	Velocity fps	Energy Ft. lb
Accuracy Load	RE 16	59.3	2900	3267
Hunting Load	IMR 4451 End.	60.7	2900	3267

Sierra does not recommend MatchKing bullets for hunting applications.

300 REMINGTON SHORT ACTION ULTRA MAG



Bullet	Caliber	Weight	Type	C.O.A.L.
	#2210	.308"	190gr. HPBT Match	2.825"
	#7795	.308"	195gr. TMK	2.910"*
*requires 1 x 10" twist or faster twist				

Powder	Velocity	2400	2500	2600	2650	2700	2750	2800
Big Game				52.4	53.6	54.9	56.2	
IMR 4350			52.2	54.4	55.5	56.6	57.6	
IMR 4451 End.			52.6	55.0	56.2	57.3	58.5	
A 4350	52.3	53.9	56.0	57.2	58.6			
H4350		51.3	54.0	55.3	56.6	57.8		
RE 16		51.0	53.1	54.2	55.4	56.6	57.9	
RE 17		50.4	52.5	53.5	54.5	55.4	56.4	
Hunter				57.1	58.3	59.5	60.8	62.0
H4831sc		55.5	57.8	59.1	60.5	62.0		
Energy Ft. Lbs		2430	2636	2851	2962	3075	3190	3307

Special Load	Powder	Grains	Velocity fps	Energy Ft. lb
Accuracy Load	H4831sc	62.0	2750	3190
Hunting Load	RE 16	57.9	2800	3307

Sierra does not recommend MatchKing bullets for hunting applications.



300 REMINGTON SHORT ACTION ULTRA MAG

	Bullet	Caliber	Weight	Type	C.O.A.L.			
	#2165	.308"	200gr.	SBT	2.825"			
	#2230	.308"	200gr.	HPBT Match	2.825"			
	#2231	.308"	200gr.	HPBT Match	3.125"*			
*requires 1 x 9" twist or faster twist								
Powder	Velocity	2400	2500	2600	2650	2700	2750	2800
IMR 4350			51.1	53.4	54.6	55.8		
IMR 4451 End.			51.6	54.0	55.1	56.2	57.2	
A 4350			52.1	54.7	56.0	57.2	58.3	
H4350			50.0	52.4	53.7	55.1		
RE 16			50.4	52.8	54.0	55.1	56.2	
RE 17				51.3	52.6	53.8	54.9	56.0
Hybrid 100V				52.7	53.9	54.9	55.7	
RE 19			55.0	57.0	58.0	59.1	60.2	61.4
Hunter			53.3	55.8	57.0	58.2	59.3	60.4
H4831sc				57.2	58.3	59.5	60.7	
IMR 4955 End.	50.4		52.8	55.0	56.0			
N560			56.4	58.4	59.4	60.4	61.4	
H1000			59.0	61.7	63.2			
Energy Ft. Lbs		2558	2775	3002	3118	3237	3358	3481
Special Load	Powder	Grains	Velocity fps	Energy Ft. lb				
Accuracy Load	RE 16	56.2	2750	3358				
Hunting Load	RE 16	56.2	2750	3358				
<i>Sierra does not recommend MatchKing bullets for hunting applications.</i>								

300 REMINGTON SHORT ACTION ULTRA MAG

Bullet		Caliber	Weight	Type	C.O.A.L.			
	#9240	.308"	210gr.	HPBT Match	2.925"			
*requires 1 x 10" twist or faster twist								
Powder	Velocity	2300	2400	2500	2550	2600	2650	2700
IMR 4350		47.3	49.9	52.5	53.8			
IMR 4451 End.			50.0	52.4	53.6	54.7		
A 4350			50.2	53.5	54.9	56.3	57.4	
H4350			48.4	51.1	52.4	53.7		
RE 16			48.7	51.4	52.7	54.0	55.2	
RE 17			48.3	50.8	52.0	53.1	54.2	
Hybrid 100V				51.1	52.4	53.5	54.6	
RE 19				56.3	57.5	58.6	59.7	60.9
Hunter			52.1	54.7	55.9	57.1	58.2	59.4
H4831sc			53.0	55.6	56.9	58.2	59.6	
IMR 4955 End.	49.6	51.9	54.4	55.6				
N560		54.5	57.0	58.1	59.1	60.0		
H1000				59.5	61.0	62.4		
Energy Ft. Lbs		2466	2685	2914	3032	3152	3274	3399
Special Load	Powder	Grains	Velocity fps	Energy Ft. lb				
Accuracy Load	RE 19	60.9	2700	3399				
<i>Sierra does not recommend MatchKing bullets for hunting applications.</i>								

300 REMINGTON SHORT ACTION ULTRA MAG

		Bullet Caliber Weight Type							C.O.A.L.
	#2240 .308" 220gr. HPBT Match								2.825"*
	#2180 .308" 220gr. RN								2.700"
*requires 1 x 10" twist or faster twist									
Powder v	Velocity >	2250	2350	2400	2450	2500	2550	2600	
IMR 4350		47.2	49.8	51.1	52.2	53.3			
IMR 4451 End.			50.3	51.6	52.7	53.8	54.9		
A 4350			48.3	50.8	52.8	54.4	55.6		
H4350			47.9	49.2	50.5	51.9	53.2		
RE 16			48.2	49.6	50.9	52.2	53.4		
RE 17			47.8	49.0	50.2	51.4	52.5	53.7	
Hybrid 100V				48.8	50.1	51.3	52.5	53.6	
RE 19			52.7	53.9	55.1	56.3	57.5	58.6	
Hunter			52.0	53.3	54.6	55.7	56.8		
H4831sc			51.8	52.9	54.1	55.4	56.9	58.6	
IMR 4955 End.	48.8		50.9	52.1	53.3	54.7			
N560			54.6	55.6	56.5	57.6	58.7	59.8	
H1000				57.2	58.6	60.0	61.4	62.8	
Energy Ft. Lbs		2473	2697	2813	2932	3053	3176	3302	
Special Load	Powder	Grains		Velocity fps		Energy Ft. lb			
Accuracy Load	H4831sc	58.6		2600		3302			
Hunting Load	RE 17	53.7		2600		3302			
<i>Sierra does not recommend MatchKing bullets for hunting applications.</i>									

300 REMINGTON SHORT ACTION ULTRA MAG

Bullet		Caliber	Weight	Type	C.O.A.L.				
	#2251	.308"	230gr.	HPBT Match	3.170"*				
*requires 1 x8" twist or faster twist									
Powder	Velocity	2250	2350	2400	2450	2500	2550	2600	
IMR 4350		47.9	50.3	51.5	52.8	54.1			
IMR 4451 End.		48.4	50.3	51.4	52.6	53.9			
A 4350		47.5	51.2	52.8	54.3	55.6			
H4350			50.4	51.7	52.9	53.9			
RE 16		49.9	51.3	52.5	53.7	54.9			
RE 17		48.9	50.0	51.1	52.3	53.5			
Hybrid 100V			49.0	50.3	51.6	53.0			
RE 19			53.8	55.1	56.4	57.6	58.7	59.7	
H4831sc			53.2	54.5	55.8	57.2	58.4		
IMR 4955 End.	49.5	51.8	53.0	54.2					
N560		55.3	56.5	57.7	58.7	59.7	60.7		
H1000			58.1	59.4	60.7	62.2	63.7		
Energy Ft. Lbs		2585	2820	2941	3065	3191	3320	3452	
Special Load	Powder	Grains	Velocity fps	Energy Ft. lb					
Accuracy Load	RE 19	59.7	2600	3452					
<i>Sierra does not recommend MatchKing bullets for hunting applications.</i>									

300 REMINGTON SHORT ACTION ULTRA MAG

Bullet		Caliber	Weight	Type	C.O.A.L.				
	#9245	.308"	240gr.	HPBT Match	2.825"*				
*requires 1 x 9" twist or faster twist									
Powder	Velocity	2100	2200	2300	2350	2400	2450	2500	
IMR 4350			47.2	49.6	50.8	52.1			
IMR 4451 End.		45.2	47.4	49.7	50.9	52.1			
A 4350			48.0	51.0	52.4	53.8	55.1		
H4350			46.1	48.7	50.0	51.4	52.9		
RE 16			46.0	48.7	50.0	51.3	52.6		
RE 17			45.4	47.5	48.7	49.9	51.2	52.6	
Hybrid 100V				46.8	48.0	49.3	50.6		
RE 19				52.3	53.6	54.9	56.1	57.4	
H4831sc				51.9	53.4	54.8	56.2	57.6	
IMR 4955 End.		45.7	47.9	50.1	51.3				
N560			51.5	53.8	54.9	56.1	57.2	58.3	
H1000				55.7	57.2	58.6	60.0	61.3	
Energy Ft. Lbs		2350	2579	2819	2942	3069	3198	3330	
Special Load	Powder	Grains	Velocity	fps	Energy	Ft. lb			
Accuracy Load	A 4350	55.1	2450		3198				
<i>Sierra does not recommend MatchKing bullets for hunting applications.</i>									