

# 300 NORMA MAGNUM

## Test Specifications:

Firearm Used: Universal

Barrel Length: 24"

Twist: 1-10"

## Components:

Case: Norma

Trim-to Length: 2.482"

Primer: WLRM

## Remarks:



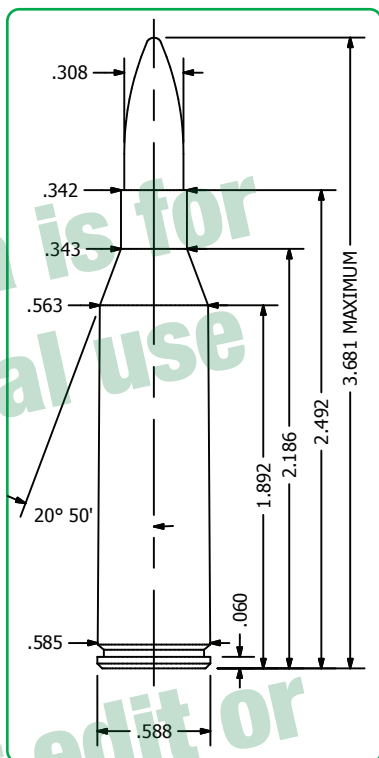

Introduced in 2012, the 300 Norma Magnum is a necked down version of a 338 Norma Magnum that was developed two years earlier. It is a completely different cartridge than the 308 Norma Magnum developed in the early 60's. The first major difference is the lack of a mag belt at the base of the case. This gives the 300 an ability to headspace from the shoulder and is considered a more desirable method.

The case length is very similar to a 30-06 but the body is significantly wider. It needs a wide bolt face to hold it but the case length is short enough

to use our 230 grain from the magnum length magazine usually associated with the bolt. Velocity performance is on par with other magnum cartridges but it has the potential to work exceptionally well with long bullets like our 230gr HPBT MatchKing. Our 230gr can travel out to over a mile while it is still at supersonic velocities putting it on par with the 338 Lapua using our 300gr HPBT MatchKing.



# 300 Norma Magnum

	Bullet	Caliber	Weight	Type	C.O.A.L.
	#2145	.308"	165gr.	SBT	3.340"
	#2140	.308"	165gr.	HPBT	3.335"
	#4665	.308"	165gr.	TGK	3.570"
	#2200	.308"	168gr.	HPBT Match	3.430"
	#7768	.308"	168gr.	TMK Match	3.540"







Powder	Velocity	2900	3000	3100	3150	3200	3250	3300	
H4350			71.8	75.1	77.0				
RE 19			78.1	81.0	82.7	84.4	86.2		
H4831sc		74.0	77.2	80.6	82.5				
N560			79.1	82.2	83.9	85.6			
N565			83.1	86.3	87.8	89.4	91.0		
N165		77.9	81.3	84.8	86.5				
RE 23			76.5	79.7	81.4	83.0			
IMR 7828			80.4	83.6	85.3	87.0			
IMR 7977 End.		83.4	86.6	89.6	91.0	92.3			
H1000				84.1	86.0	87.9			
Retumbo			83.4	87.0	88.7	90.4	91.9		
RE 33			92.4	95.9	97.5	99.1	100.6	102.0	
<b>Energy Ft. Lbs</b>			<b>3081</b>	<b>3297</b>	<b>3520</b>	<b>3635</b>	<b>3751</b>	<b>3869</b>	<b>3989</b>

Special Load	Powder	Grains	Velocity fps	Energy Ft. lb
<b>Accuracy Load</b>	RE 23	83.0	3200	3751
<b>Hunting Load</b>	RE 33	102.0	3300	3989

*Sierra does not recommend MatchKing bullets for hunting applications.*

# 300 NORMA MAGNUM

Bullet	Caliber	Weight	Type	C.O.A.L.
	#2275	.308"	175gr. HPBT Match	3.425"
	#7775	.308"	175gr. TMK Match	3.550"
	#2150	.308"	180gr. SPT	3.440"
	#2160	.308"	180gr. SBT	3.430"
	#2220	.308"	180gr. HPBT Match	3.440"
	#2170	.308"	180gr. RN	3.210"



Powder	Velocity	2800	2900	3000	3050	3100	3150	3200
H4831sc			75.1	78.7	80.6			
N560			77.4	80.5	82.2	84.0		
N565			81.5	84.6	86.2	87.8	89.4	
N165	76.6	80.8	83.8					
RE 23		74.8	78.4	80.2	81.9			
IMR 7828	76.2	79.1	82.1	83.7	85.3			
RE 25		81.7	84.8	86.3	87.7	89.2		
IMR 7977 End.	81.6	84.4	87.1	88.4	89.7			
H1000		80.1	83.4	85.1	86.7			
Retumbo		81.9	84.9	86.4	88.0	89.7		
RE 33		90.3	93.5	95.0	96.6	98.2	99.8	
<b>Energy Ft. Lbs</b>		<b>3046</b>	<b>3267</b>	<b>3497</b>	<b>3614</b>	<b>3734</b>	<b>3855</b>	<b>3978</b>



Special Load	Powder	Grains	Velocity fps	Energy Ft. lb
<b>Accuracy Load</b>	IMR 7828	85.3	3100	3734
<b>Hunting Load</b>	RE 33	99.8	3200	3978

*Sierra does not recommend MatchKing bullets for hunting applications.*

# 300 Norma Magnum

		Bullet	Caliber	Weight	Type	C.O.A.L.				
		#2210	.308"	190gr.	HPBT Match	3.460"				
		#7795	.308"	195gr.	TMK Match	3.550"*				
*requires 1 x 10" twist or faster twist										
Powder	Velocity	2700	2800	2900	2950	3000	3050	3100		
H4831sc			72.1	75.5	77.2	78.9				
N565			79.6	82.7	84.2	85.7				
N165		72.2	75.4	78.8	80.6					
RE 23			72.2	75.4	77.1	78.7	80.4			
IMR 7828			75.1	78.2	79.8	81.4	83.0			
IMR 7977 End.			80.8	83.4	84.8	86.3	87.8			
H1000				80.4	82.2	84.0	85.7	87.5		
Retumbo				81.8	83.4	85.0	86.6	88.3		
RE 33				90.0	91.4	92.8	94.3	95.7		
<b>Energy Ft. Lbs</b>		<b>3075</b>	<b>3307</b>	<b>3547</b>	<b>3671</b>	<b>3796</b>	<b>3924</b>	<b>4054</b>		
Special Load	Powder	Grains	Velocity fps	Energy Ft. lb						
<b>Accuracy Load</b>	H4831sc	78.9	3000	3796						
<i>Sierra does not recommend MatchKing bullets for hunting applications.</i>										

# 300 Norma Magnum

Bullet	Caliber	Weight	Type	C.O.A.L.
	#2165	.308"	200gr. SBT	3.450"
	#2230	.308"	200gr. HPBT Match	3.450"
	#2231	.308"	200gr. HPBT Match	3.730"*
*requires 1 x 9" twist or faster twist				

Powder	Velocity	2600	2700	2800	2850	2900	2950	3000
N565			75.7	79.4	81.0	82.5	83.9	
N165	68.7	72.2	75.5	77.2				
RE 23		69.1	72.7	74.5	76.3			
IMR 7828		72.0	75.2	76.9	78.6	80.3		
RE 25			79.1	80.5	82.1	83.8	85.5	
IMR 7977 End.		76.8	79.7	81.2	82.8	84.4		
H1000			77.3	79.1	80.9	82.7		
Retumbo			79.5	81.5	83.4	85.3	87.1	
RE 33				87.8	89.6	91.3	93.0	
IMR 8133			84.5	86.1	87.8	89.3		
24N41			89.9	91.8	93.5	95.0		
US869			96.2	97.9	99.7	101.4	103.1	
<b>Energy Ft. Lbs</b>		<b>3002</b>	<b>3237</b>	<b>3481</b>	<b>3607</b>	<b>3734</b>	<b>3864</b>	<b>3996</b>



Special Load*	Powder	Grains	Velocity fps	Energy Ft. lb
<b>Accuracy Load</b>	24N41	95.0	2950	3864
<b>Hunting Load</b>	RE 25	85.5	3000	3996

Sierra does not recommend MatchKing bullets for hunting applications.

# 300 Norma Magnum

		Bullet Caliber Weight Type						C.O.A.L.
		#9240 .308" 210gr. HPBT Match						3.520"*
		*requires 1 x 10" twist or faster twist						
Powder	Velocity	2500	2600	2700	2800	2900	2950	
N565				76.8	80.1	83.5		
N165		67.1	71.1	74.9				
RE 23				71.7	75.6			
IMR 7828			71.3	74.6	78.0			
RE 25				77.0	80.4	83.9		
IMR 7977 End.			76.2	79.5	82.7	85.9		
H1000				74.2	78.2	82.4		
Retumbo				76.0	80.2	84.3		
RE 33					84.6	89.8	91.8	
IMR 8133				81.6	85.7	89.2		
24N41					89.9	94.2		
US869				93.1	96.2	99.5	101.2	
<b>Energy Ft. Lbs</b>		<b>2914</b>	<b>3152</b>	<b>3399</b>	<b>3655</b>	<b>3921</b>	<b>4057</b>	
Special Load	Powder	Grains		Velocity fps		Energy Ft. lb		
<b>Accuracy Load</b>	IMR 8133	89.2		2900		3921		
<i>Sierra does not recommend MatchKing bullets for hunting applications.</i>								

## 300 NORMA MAGNUM

Bullet	Caliber	Weight	Type	C.O.A.L.
	#2240	.308"	220gr. HPBT Match	3.460"*
	#2180	.308"	220gr. RN	3.200"
*requires 1 x 10" twist or faster twist				

Powder	Velocity	2450	2550	2650	2750	2800	2850	2900
N565				75.2	78.8	80.5	82.2	
N165			70.7	74.9				
RE 23				70.2	74.2			
IMR 7828				73.0	76.4	78.2		
RE 25				75.5	78.7	80.3	81.8	
IMR 7977 End.				77.6	80.8	82.4		
H1000				72.9	76.9	78.9		
Retumbo					78.6	80.7	82.8	
RE 33					83.4	85.4	87.4	89.3
IMR 8133				80.4	84.0	85.8		
24N41				84.6	88.2	90.3	92.6	
US869	83.0	86.7	90.4	94.2	96.1	98.0	99.9	
<b>Energy Ft. Lbs</b>	<b>2932</b>	<b>3176</b>	<b>3430</b>	<b>3694</b>	<b>3829</b>	<b>3967</b>	<b>4108</b>	

Special Load	Powder	Grains	Velocity fps	Energy Ft. lb
<b>Accuracy Load</b>	RE 23	74.2	2750	3694
<b>Hunting Load</b>	RE 33	89.3	2900	4108

Sierra does not recommend MatchKing bullets for hunting applications.

# 300 Norma Magnum

		Bullet Caliber Weight Type							C.O.A.L.
		#2251 .308" 230gr. HPBT Match							3.775"*
		*requires 1 x8" twist or faster twist							
Powder v	Velocity >	2500	2600	2700	2750	2800	2850	2900	
N565			74.6	78.2	80.0				
N165	70.4	74.3							
RE 23		71.1	74.9						
IMR 7828		73.6	77.2	79.0					
RE 25			78.5	80.1	81.7				
IMR 7977 End.		77.7	81.0	82.7					
H1000		73.8	77.3	79.3					
Retumbo			79.0	80.9	82.8				
RE 33			85.2	87.3	89.3	91.2			
IMR 8133			80.0	83.4	85.1	86.8			
24N41			83.4	87.0	89.0	91.0			
US869				93.6	95.3	97.0	98.7	100.5	
<b>Energy Ft. Lbs</b>		<b>3191</b>	<b>3452</b>	<b>3722</b>	<b>3862</b>	<b>4003</b>	<b>4147</b>	<b>4294</b>	
Special Load	Powder	Grains	Velocity fps	Energy Ft. lb					
<b>Accuracy Load</b>	H1000	79.3	2750	3862					
<i>Sierra does not recommend MatchKing bullets for hunting applications.</i>									



## 300 Norma Magnum

Bullet Caliber Weight Type		C.O.A.L.						
	#9245 .308" 240gr. HPBT Match	3.450"*						
*requires 1 x 9" twist or faster twist								
Powder ▾	Velocity >	2350	2450	2500	2550	2600	2650	2700
N565			69.5	71.2	72.9	74.6	76.2	77.9
N165	65.4	69.5	71.3	73.0				
RE 23		66.9	68.8	70.7	72.6			
IMR 7828		69.6	71.4	73.1	74.8	76.4		
RE 25			71.7	73.9	76.2	78.4	80.7	
IMR 7977 End.		74.4	76.2	77.8	79.3	80.6		
H1000		68.6	70.5	72.3	74.0	75.7		
Magnum		73.9	75.5	77.2	78.8	80.4		
Retumbo			71.7	73.7	75.7	77.5	79.3	
RE 33			78.9	80.6	82.3	84.0	85.7	
IMR 8133		74.6	76.3	78.0	79.7	81.3		
24N41		78.7	80.5	82.3	84.0	85.8		
US869				87.3	89.1	90.8	92.5	
<b>Energy Ft. Lbs</b>		<b>2942</b>	<b>3198</b>	<b>3330</b>	<b>3465</b>	<b>3602</b>	<b>3742</b>	<b>3884</b>
Special Load	Powder	Grains	Velocity fps	Energy Ft. lb				
<b>Accuracy Load</b>	RE 25	80.7	2700	3884				
<i>Sierra does not recommend MatchKing bullets for hunting applications.</i>								