

300 AAC BLACKOUT

Test Specifications:

Firearm Used: Universal

Barrel Length: 16"

Twist: 1- 8"

Components:

Case: Hornady

Trim-to Length: 1.363"

Primer: WSR

Remarks:

The .300 AAC Blackout (300 BLK) was developed by Advance Armament Corporation to deliver increased energy on targets at close range over the 5.56 NATO. The cartridge was designed so that AR15/M16 magazines could be utilized at their standard capabilities with no reduced capacity. All that is need to convert a



5.56x45 NATO AR15/M16 is to swap the upper receiver and barrel. The 300 BLK also functions well in suppressors at both super and subsonic levels due to it utilization of faster burning powders. At supersonic levels, the 300 BLK offers close range ballistics on par with that of the 7.62x39mm. When loaded at subsonic levels in short barreled submachine guns, it offers greater energy and increased accuracy at longer ranges compared to the 9mm Luger.

When proper bullets are utilized, the 300 Blackout can prove to be capable for short range as a medium game and varmint cartridge. Bullets like the 135gr Varminter #2124 offer excellent performance on white tail deer, expanding even at low velocities. The 110gr Varminter #2110 offers great performance for hunting coyotes and foxes delivering the knock down power but not the pelt destructiveness of higher velocity cartridges. Its low recoil and muzzle blast make it excellent for those that are extremely recoil shy.

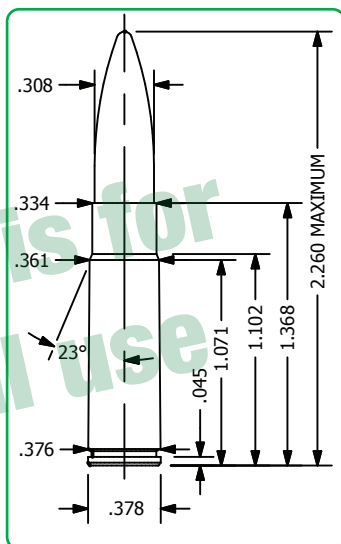
With the large variety of manufacturers making uppers, barrels, and gas blocks for AR15s, reloaders will need to experiment to find a load that reliably cycles their individual firearm and delivers the accuracy they desire when loading subsonic rounds. Powders like Hodgdon CFE BLK and Shooters World BLACKOUT function well with subsonic loads. Those seeking to cycle the AR 15 should avoid Hodgdon Trail Boss with any bullet weight. With bullets larger than 200gr, Reloader 7, IMR 4198 and H4198 may not produce the pressures needed to cycle an AR15. These powders are also perfectly acceptable in single shot pistols and bolt action rifles.





300 AAC BLACKOUT



		Bullet	Caliber	Weight	Type	C.O.A.L.			
		#2100	.308"	110gr.	RN	1.845"			
		#2105	.308"	110gr.	FMJ	1.845"			
		#2110	.308"	110gr.	HP	1.970"			
Powder	Velocity	1800	1900	2000	2100	2200	2300	2400	
Enforcer					16.8	18.0	19.4		
N110			13.8	14.8	16.1				
N105		11.5	12.3	13.1					
H110					17.0	17.6	18.6	19.9	
Win 296						18.2	19.4	20.5	
IMR 4227			17.4	18.3	19.5				
CFE BLK			20.0	21.1	22.3	23.4			
IMR 4198		18.1	19.1						
H4198		18.4	19.2						
Energy Ft. Lbs		791	882	977	1077	1182	1292	1407	
Special Load	Powder	Grains	Velocity	fps	Energy	Ft. lb			
Accuracy Load	H110	19.9	2400		1407				
Hunting Load	H110	19.9	2400		1407				

This data is for individual use only. Do not edit or redistribute.









300 AAC BLACKOUT

	Bullet	Caliber	Weight	Type	C.O.A.L.			
	#2120	.308"	125gr.	SPT	2.030"			
	#2121	.308"	125gr.	HP Match	2.250"			
	#7725	.308"	125gr.	TMK Match	2.250"			
Powder	Velocity	1600	1700	1800	1900	2000	2100	2200
N110			12.6	13.4	14.4	15.5		
N105		10.5	11.2	12.1	13.0			
H110						16.4	17.3	18.5
Win 296					16.2	17.0	18.0	19.0
IMR 4227		15.0	15.9	16.9	18.0			
A 1680		17.2	18.1	19.1	20.0	21.0		
CFE BLK			18.1	19.1				
RE 7		17.4	18.4	19.4				
IMR 4198		16.4	17.4	18.3				
H4198		16.8	17.4	18.0	18.4	18.8		
Energy Ft. Lbs		710	802	899	1002	1110	1224	1343
Special Load	Powder	Grains	Velocity	fps	Energy	Ft. lb		
Accuracy Load	CFE BLK	19.1	1800		899			
Hunting Load	H110	18.5	2200		1343			
<i>Sierra does not recommend MatchKing bullets for hunting applications.</i>								





300 AAC BLACKOUT

		Bullet	Caliber	Weight	Type	C.O.A.L.			
	#2123	.308"	135gr.	HPBT	Match	2.160"			
	#2124	.308"	135gr.	HP		2.030"			
Powder	Velocity	1040	1600	1700	1800	1900	2000	2100	
Trail Boss	7.2								
Enforcer					15.2	16.3	17.3	18.4	
N110			12.2	12.9	14.0	15.3			
N105			10.8	11.6	12.6				
H110					15.2	16.4	17.5	18.7	
Win 296						16.3	17.5		
IMR 4227			15.0	16.1	17.1	18.2			
A 1680			16.9	17.9	19.1	20.6			
CFE BLK			17.4	18.4	19.4	20.5	21.6		
RE 7	11.7	17.6	18.6	19.6					
IMR 4198	11.7	16.5	17.5	18.4					
H4198	11.6	16.6	17.6	18.5					
Energy Ft. Lbs	324	767	866	971	1082	1199	1322		
Special Load	Powder	Grains	Velocity	fps	Energy	Ft. lb			
Accuracy Load	IMR 4198	18.4	1800		971				
Hunting Load	Enforcer	18.4	2100		1322				
<i>Sierra does not recommend MatchKing bullets for hunting applications.</i>									







300 AAC BLACKOUT

	Bullet	Caliber	Weight	Type	C.O.A.L.			
	#2115	.308"	150gr.	FMJBT	2.140"			
	#2130	.308"	150gr.	SPT	2.140"			
	#2125	.308"	150gr.	SBT	2.140"			
	#2190	.308"	150gr.	HPBT Match	2.155"			
	#2135	.308"	150gr.	RN	1.860"			
	#2155	.308"	155gr.	HPBT Match	2.140"			
	#2156	.308"	155gr.	HPBT Match Palma	2.190"			
	#7755	.308"	155gr.	TMK Match	2.250"			
Powder	Velocity	1050	1400	1500	1600	1700	1800	1900
Trail Boss		7.3						
Enforcer				12.2	12.8	13.6	14.7	
N110				11.2	12.1	13.3	14.6	
N105	9.1	9.3	9.9	10.8				
H110			13.0	13.5	14.2	15.1	16.3	
Win 296			13.1	13.7	14.5	15.4	16.4	
IMR 4227			13.1	14.0	14.9	16.0	17.1	
A 1680				16.6	17.6	18.7	19.8	
CFE BLK			15.0	15.8	16.8	17.8	18.8	20.0
RE 7	11.5	14.8	15.9	16.9	18.0			
IMR 4198		11.6	14.5	15.4	16.4	17.4		
H4198		11.7	14.6	15.5	16.4	17.4		
Energy Ft. Lbs		367	653	749	853	962	1079	1202
Special Load	Powder	Grains	Velocity fps	Energy Ft. lb				
Accuracy Load	IMR 4227	17.1	1800	1079				
Hunting Load	H110	16.3	1900	1202				
<i>Sierra does not recommend MatchKing bullets for hunting applications.</i>								

300 AAC BLACKOUT

Bullet		Caliber	Weight	Type	C.O.A.L.							
	#2145	.308"	165gr.	SBT	2.180"							
	#2140	.308"	165gr.	HPBT	2.120"							
	#2200	.308"	168gr.	HPBT Match	2.180"							
	#7768	.308"	168gr.	TMK Match	2.250"							
Powder	Velocity	1050	1300	1400	1500	1600	1700	1800				
N110			10.1	10.8	11.6	12.6	13.9					
Lil Gun					11.2	11.9	13.0	14.6				
H110				12.3	13.0	13.7	14.6	15.7				
Win 296				12.2	12.9	13.7	14.7	15.7				
IMR 4227				13.3	14.1	15.0	16.1					
A 1680					15.7	16.7	17.7	18.9				
CFE BLK			14.2	15.1	16.0	17.0	18.1	19.3				
RE 7	11.5	14.1	15.1	16.1	17.1							
IMR 4198	11.5	13.3	14.2	15.1	16.1							
H4198	11.6	13.5	14.4	15.3	16.3							
Energy Ft. Lbs	404	619	718	824	938	1059	1187					
Special Load	Powder	Grains	Velocity fps	Energy Ft. lb								
Accuracy Load	H4198	16.3	1600	938								
Hunting Load	Lil Gun	14.6	1800	1187								
<i>Sierra does not recommend MatchKing bullets for hunting applications.</i>												

300 AAC BLACKOUT





Bullet	Caliber	Weight	Type	C.O.A.L.
	#2275	.308"	175gr. HPBT Match	2.180"
	#7775	.308"	175gr. TMK Match	2.250"
	#2150	.308"	180gr. SPT	2.180"
	#2160	.308"	180gr. SBT	2.180"
	#2220	.308"	180gr. HPBT Match	2.200"
	#2170	.308"	180gr. RN	2.110"

Powder	Velocity	1050	1300	1400	1500	1600	1700	1800
N110			10.1	10.9	11.9	13.0		
H110			11.1	11.9	12.8	13.8	14.8	
Win 296			11.7	12.6	13.4	14.3		
IMR 4227			12.6	13.5	14.4	15.5		
A 1680					16.1	17.2	18.2	19.2
CFE BLK			13.9	15.0	16.1	17.2	18.4	
RE 7		11.2	13.8	14.8	15.9	17.0		
IMR 4198		11.3	13.2	14.2	15.2	16.4		
H4198		11.5	13.7	14.7	15.6	16.5		
Energy Ft. Lbs		428	657	761	874	995	1123	1259

Special Load	Powder	Grains	Velocity fps	Energy Ft. lb
Accuracy Load	CFE BLK	18.4	1700	1123
Hunting Load	A 1680	19.2	1800	1259

Sierra does not recommend MatchKing bullets for hunting applications.

300 AAC BLACKOUT

Bullet	Caliber	Weight	Type	C.O.A.L.
	#2210	.308"	190gr. HPBT Match	2.230"
	#7795	.308"	195gr. TMK	2.250"*
	#2165	.308"	200gr. SBT	2.210"
	#2230	.308"	200gr. HPBT Match	2.230"



*requires 1 x 10" twist or faster twist

Powder	Velocity	900	1000	1100	1200	1300	1400	1500
N110			8.4	9.0	9.7	10.6	11.6	
H110			9.4	10.3	11.2	12.0	12.8	13.6
Win 296	9.2		9.7	10.4	11.1	11.9		
IMR 4227	9.3		9.9	10.7	11.6	12.7		
A 1680			11.3	12.2	13.2	14.2	15.4	16.5
Blackout				11.8	12.9	13.8	14.7	
CFE BLK			11.2	12.2	13.2	14.3	15.5	16.7
RE 7	10.4		11.2	12.0	12.9	13.9		
IMR 4198	10.3		10.8	11.5	12.3	13.3	14.4	
H4198				11.4	12.3	13.4	14.5	
Energy Ft. Lbs		342	422	510	607	713	827	949

Special Load	Powder	Grains	Velocity fps	Energy Ft. lb
Accuracy Load	N110	11.6	1400	827
Hunting Load	H110	13.6	1500	949

Sierra does not recommend MatchKing bullets for hunting applications.

300 AAC BLACKOUT

Bullet	Caliber	Weight	Type	C.O.A.L.
	#9240	.308"	210gr. HPBT Match	2.250"*
	#2240	.308"	220gr. HPBT Match	2.230"*
	#2180	.308"	220gr. RN	2.100"
*requires 1 x 10" twist or faster twist				

Powder	Velocity	900	1000	1100	1200	1300	1400	1500
N110		7.8	8.4	9.2	10.1			
H110			9.7	10.5	11.2	11.9		
Win 296		9.2	9.7	10.4	11.1	11.9		
IMR 4227		9.3	9.9	10.7	11.6	12.7		
A 1680			11.3	12.2	13.2	14.2	15.4	16.5
Blackout				11.8	12.9	13.9	14.7	
CFE BLK			11.3	12.2	13.2	14.3	15.4	16.7
RE 7		10.4	11.2	12.0	12.9	13.9		
IMR 4198		10.3	10.8	11.5	12.3	13.3	14.4	
H4198				11.4	12.3	13.4	14.5	
Energy Ft. Lbs		378	466	564	671	788	914	1049

Special Load	Powder	Grains	Velocity fps	Energy Ft. lb
Accuracy Load	IMR 4227	12.7	1300	788
Hunting Load	A 1680	16.5	1500	1049

Sierra does not recommend MatchKing bullets for hunting applications.

300 AAC BLACKOUT

		Bullet	Caliber	Weight	Type	C.O.A.L.				
			#2251	.308"	230gr.	HPBT Match	2.250"*			
		*requires 1 x 8" twist or faster twist								
Powder	Velocity	300	900	1000	1100	1200	1300	1400		
2400				7.9	8.7					
N110			7.4	8.4	9.4					
Lil Gun				7.7	8.6	9.6	10.8	12.1		
H110			7.8	8.6	9.5	10.3				
Win 296					9.2	10.2				
IMR 4227			8.5	9.4	10.3	11.4				
A 1680			9.1	9.7	10.8	12.4	14.5			
Blackout			9.6	10.4	11.3	12.4	13.7			
CFE BLK				10.0	11.3	12.6				
RE 7		9.1	9.6	10.4	11.4	12.8				
IMR 4198			9.5	10.3	11.3	12.4				
H4198				10.4	11.3	12.4				
N120				9.7	10.6	11.6				
Energy Ft. Lbs		327	414	511	618	735	863	1001		
Special Load	Powder	Grains	Velocity	fps		Energy	Ft. lb			
Accuracy Load	N120	11.6	1200			735				
<i>Sierra does not recommend MatchKing bullets for hunting applications.</i>										

300 AAC BLACKOUT

Bullet		Caliber	Weight	Type	C.O.A.L.					
		#9245	.308"	240gr.	HPBT Match	2.230"*				
*requires 1 x 9" twist or faster twist										
Powder	Velocity	850	950	1050	1150	1200	1250	1300		
IMR 4227			9.5	10.2	11.0	11.4				
A 1680				11.4	12.3	12.9	13.5	14.3		
Blackout				11.4	12.2	12.7	13.1	13.6		
CFE BLK		10.0	10.6	11.4	12.5	13.1	13.8	14.6		
RE 7			10.6	11.4	12.2					
IMR 4198			10.2	10.9	11.8	12.4	13.0			
H4198			10.2	10.9	11.8	12.4	12.9			
Energy Ft. Lbs		385	481	587	705	767	833	900		
Special Load	Powder	Grains	Velocity fps	Energy Ft. lb						
Accuracy Load	A 1680	14.3	1300	900						
<i>Sierra does not recommend MatchKing bullets for hunting applications.</i>										

Do not edit or redistribute.