

30 NOSLER

Test Specifications:

Firearm Used: Universal

Barrel Length: 24"

Twist: 1-10"

Components:

Case: Norma

Trim-to Length: 2.536"

Primer: WLRM

Remarks:

Call it a "do-everything" cartridge with enough power to handle long range precision shots, yet able to be handled by novices - unlike many of the "big bruin" thumpers. Think: .300 Win Mag, but 250 fps faster just about across the board, and with less felt recoil.



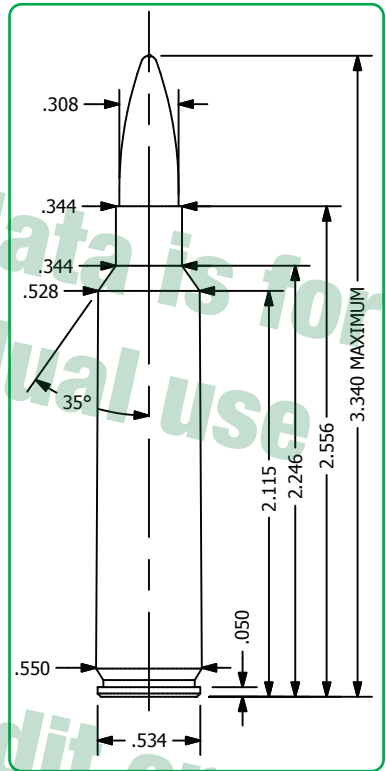

Based on the .404 Jeffry, it has the same case wall diameter as the .300 WM, but without the bulk and shortcomings of a belt. This allows head-spacing on the shoulder for better accuracy, too. A shorter case offers a longer neck, allowing bullets to be seated deeper than in the .300 WM. Long ogive bullets can be seated correctly and that combo spells long-range accuracy!

The .30 Nosler sending a 180 gr. bullet at about 3,100 fps is faster than a .300 WM, and zeroed at 200 yards, can produce just 5" or so drop at 300, about 16" at 400 and 125" at 800, depending upon the exact load. While you could use it for local white tail deer, the .30 Nosler is more of a high performance cartridge suitable for the biggest game in North America, at the longest distances, if you're able to make the shot. And, it would be right at home hunting any plains game Africa offers.

A hunter would be ready to tackle any dream hunt possible. My own .300 WM gathers dust these days! Roy Huntington



30 Nosler







	Bullet	Caliber	Weight	Type	C.O.A.L.
	#2145	.308"	165gr.	SBT	3.340"
	#2140	.308"	165gr.	HPBT	3.325"
	#4665	.308"	165gr.	TGK	3.340"
	#2200	.308"	168gr.	HPBT Match	3.385"
	#7768	.308"	168gr.	TMK Match	3.500"

Powder	Velocity	3000	3050	3100	3150	3200	3250	3300
H4831sc		73.2	74.8	76.3	77.9	79.4	81.0	
RE 22				73.3	74.7	76.1	77.5	
N560		74.2	75.6	77.0	78.4	79.7	80.9	
RE 23		70.9	72.4	73.9	75.4	76.8	78.2	
IMR 7828ssc		75.9	77.2	78.4	79.6	80.7		
H1000		78.4	79.7	81.0	82.3	83.6	85.0	
RE 26		75.6	76.7	77.9	79.0	80.2	81.5	82.7
Magnum		81.9	83.3	84.7	85.9	87.0	88.0	
Retumbo		79.2	80.5	81.7	83.0	84.3	85.5	
Energy Ft. Lbs		3297	3408	3520	3635	3751	3869	3989

Special Load	Powder	Grains	Velocity fps	Energy Ft. lb
Accuracy Load	N560	80.9	3250	3869
Hunting Load	H4831sc	81.0	3250	3869

Sierra does not recommend MatchKing bullets for hunting applications.

30 Nosler



Bullet	Caliber	Weight	Type	C.O.A.L.
	#2275	.308"	175gr. HPBT Match	3.385"
	#7775	.308"	175gr. TMK Match	3.500"
	#2150	.308"	180gr. SPT	3.340"
	#2160	.308"	180gr. SBT	3.340"
	#2220	.308"	180gr. HPBT Match	3.400"
	#2170	.308"	180gr. RN	3.245"

Powder	Velocity	2800	2850	2900	2950	3000	3050	3100
H4831sc		69.1	70.9	72.6	74.4	76.1	77.7	
RE 22		65.9	67.4	69.0	70.6	72.3	74.0	
N560		68.8	70.4	71.9	73.4	74.8	76.2	77.6
RE 23			68.1	69.7	71.2	72.8	74.3	75.9
IMR 7828ssc		71.0	72.3	73.7	75.1	76.5	77.9	
H1000			73.9	76.0	77.9	79.7	81.3	82.8
RE 26		71.6	72.9	74.3	75.6	77.0	78.4	79.8
Magnum		75.3	77.4	79.3	81.1	82.7	84.1	85.4
Retumbo		75.9	77.7	79.5	81.1	82.7	84.2	85.6
Energy Ft. Lbs		3046	3156	3267	3381	3497	3614	3734



Special Load	Powder	Grains	Velocity fps	Energy Ft. lb
Accuracy Load	RE 26	79.8	3100	3734
Hunting Load	N560	77.6	3100	3734

Sierra does not recommend MatchKing bullets for hunting applications.

30 Nosler

	Bullet	Caliber	Weight	Type	C.O.A.L.			
	#2165	.308"	200gr.	SBT	3.340"			
	#2230	.308"	200gr.	HPBT Match	3.420"			
	#2231	.308"	200gr.	HPBT Match	3.640"*			
*requires 1 x 9" twist or faster twist								
Powder	Velocity	2700	2750	2800	2850	2900	2950	3000
H4831sc				69.2	71.1	73.3	75.7	
IMR 7828ssc	67.6	69.0	70.5	72.0	73.6	75.2		
RE 25		72.4	74.0	75.5	77.0	78.4	79.9	
H1000	69.2	70.8	72.5	74.3	76.1	77.9		
RE 26				72.5	74.0	75.9	78.2	
Magnum	73.3	74.6	76.0	77.6	79.3	81.3	83.4	
Retumbo			73.8	75.8	77.7	79.2	80.5	
N570			75.2	77.0	78.7	80.3	82.0	
IMR 8133	74.2	76.1	78.0	79.7	81.4	83.0		
Energy Ft. Lbs		3237	3358	3481	3607	3734	3864	3996
Special Load	Powder	Grains	Velocity fps	Energy Ft. lb				
Accuracy Load	RE 25	79.9	3000	3996				
Hunting Load	Retumbo	80.5	3000	3996				
<i>Sierra does not recommend MatchKing bullets for hunting applications.</i>								

30 Nosler

	Bullet	Caliber	Weight	Type	C.O.A.L.			
	#9240	.308"	210gr.	HPBT Match	3.400"*			
	#2240	.308"	220gr.	HPBT Match	3.400"*			
	#2180	.308"	220gr.	RN	3.240"			
*requires 1 x 10" twist or faster twist								
Powder	Velocity	2500	2550	2600	2650	2700	2750	2800
H4831sc				62.9	64.5	66.1	67.8	
IMR 7828ssc			63.7	65.1	66.7	68.3	70.0	
RE 25			65.7	67.6	69.4	71.2	72.9	74.4
H1000					67.8	69.7	71.4	73.0
RE 26					66.6	68.2	69.8	71.3
Magnum				70.5	72.4	74.1	75.7	77.1
Retumbo						71.0	72.7	74.4
N570					70.9	72.6	74.3	75.9
IMR 8133		69.2	70.9	72.6	74.2	75.9	77.5	79.1
Energy Ft. Lbs		3053	3176	3302	3430	3561	3694	3829
Special Load	Powder	Grains	Velocity fps	Energy Ft. lb				
Accuracy Load	IMR 7828ssc	70.0	2750	3694				
Hunting Load	RE 25	74.4	2800	3829				
<i>Sierra does not recommend MatchKing bullets for hunting applications.</i>								

30 Nosler

Bullet Caliber Weight Type
C.O.A.L.

 #2251 .308" 230gr. HPBT Match 3.715"

*requires 1 x 8" twist or faster twist

Powder ▾	Velocity >	2500	2550	2600	2650	2700	2750	2800
H4831sc				65.1	67.6	69.5		
IMR 7828ssc			65.1	66.7	68.4	70.0	71.7	
RE 25	66.5	68.0	69.5	71.1	72.7	74.4	76.1	
H1000			67.9	69.4	71.2	73.2		
RE 26			66.3	68.1	69.8	71.4	72.9	
Magnum				73.5	75.8	77.6	78.9	
Retumbo				71.8	73.8	76.0		
N570				71.6	73.4	75.0	76.6	78.1
IMR 8133	70.3	71.9	73.5	75.2	76.9	78.6		
Energy Ft. Lbs	3191	3320	3452	3586	3722	3862	4003	

Special Load	Powder	Grains	Velocity fps	Energy Ft. lb
Accuracy Load	IMR 7828ssc	71.7	2750	3862

Sierra does not recommend MatchKing bullets for hunting applications.

 30 Nosler
 Photo: Suzie Huntington