

# 7mm-08 Remington

## Test Specifications:

Firearm Used: Universal

Barrel Length: 24"

Twist: 1- 9"

## Components:

Case: Winchester

Trim-to Length: 2.025"

Primer: WLR

## Remarks:

Virtually every cartridge ever adopted by the U.S. military has been pounced on by wildcatters, and the 7.62x51mm NATO (.308 Winchester) is no exception. Much like its forerunner, the 30/06 Springfield, the 308 spawned an immediate family of cartridges that became factory numbers. Winchester, for example saw the potential of the 243 and 358 and wasted no time adding both to their stable. Other 308

based wildcats, such as Warren Page's 25 Souper and the 270-308, attracted some interest, but were never standardized. Another was the 7mm-308, simply the 308 case necked down to accept 7mm bullets. Other than being a tad shorter than the commercial version, this was very close to the final Remington eventually adopted.

Although the cartridge had been designed and rifles chambered for it prior to 1960, not enough commercial interest was generated to really get the renamed Remington 7mm-08 off the ground. Then came silhouette shooting. Competitive shooters soon found that the neglected little wildcat had a near ideal combination of flat trajectory, adequate power, and mild recoil. As a result, the cartridge was standardized by Remington in 1980. The fact that they initially chambered it in the heavy-barreled Model 700 Varmint Special was in direct response to the silhouette game. For many years, this model has been one of the favorite "out-of-the-box" rifles for this demanding sport.

Regardless of the reasons for its eventual adoption, the 7mm-08 is an impressive performer in its own right. In the field, its performance is virtually identical to that of the time-proven 7x57mm Mauser. In a light, fast handling carbine, such as the Remington Model Seven, the 7mm-08 may be the ideal white tail deer rifle for heavy cover. The 120 grain Pro-Hunter spitzer is a very remarkable whitetail and antelope bullet. Sierra's 140 and 150 grain spitzer boat tail bullets make the most of the 7mm-08's flat shooting capabilities, while the 150 and 168 grain MatchKings are the best choice for competitive shooting. When loaded with the devastating 100 grain varmint bullets, pests and predators can be taken cleanly to 300 yards or more. Like most of the 308 family of cartridges, the 7mm-08 gives good results with a wide variety of component combinations. With very manageable recoil and superb accuracy the 7mm-08 is a perfect starter cartridge for new hunters. Experienced hunters certainly appreciated the cartridge for its reliability in the field.

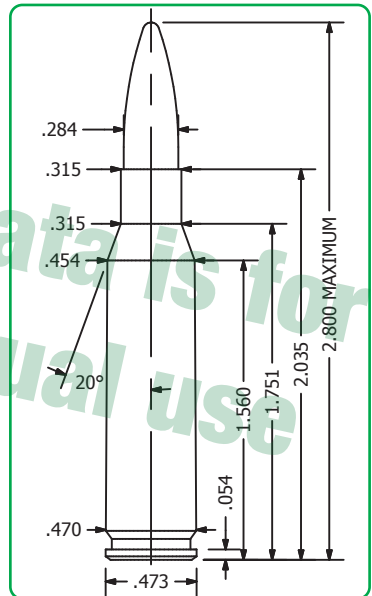

## 7mm-08 REMINGTON

Bullet		Caliber	Weight	Type	C.O.A.L.			
	#1895	.284"	100gr.	HP	2.685"			
Powder	Velocity	2800	2900	3000	3100	3200	3300	3400
IMR 8208 XBR			40.5	42.1	43.6	45.0	46.4	
H4895			40.4	41.7	43.0	44.4	45.8	
IMR 4895			41.0	42.4	43.8	45.3	46.8	
IMR 4166 End.			40.7	42.0	43.4	44.8		
IMR 4064		40.6	41.9	43.4	44.8	46.3		
A 4064		39.6	41.1	42.5	43.9	45.2		
RE 15		41.4	42.7	44.0	45.3	46.6	47.8	
N140		41.4	42.7	44.1	45.5	46.9	48.4	
Varget			41.6	43.2	44.8	46.3	47.8	
IMR 4320		41.1	42.5	43.8	45.1	46.4	47.6	
Win 748			42.2	43.6	45.1	46.6	48.2	
CFE 223				44.6	45.7	47.0	48.5	50.1
Power Pro 2000 MR			44.8	45.9	47.2	48.5	50.0	51.5
Big Game		42.7	44.4	46.2	47.9	49.8		
Win 760		44.7	46.4	48.0	49.7			
RE 17		45.5	47.0	48.4	49.6	50.7		
<b>Energy Ft. Lbs</b>		<b>1741</b>	<b>1867</b>	<b>1998</b>	<b>2133</b>	<b>2273</b>	<b>2418</b>	<b>2566</b>
Special Load	Powder	Grains	Velocity fps	Energy Ft. lb				
<b>Accuracy Load</b>	Big Game	49.8	3200	2273				
<b>Hunting Load</b>	CFE 223	50.1	3400	2566				



# 7mm-08 Remington

		Bullet Caliber Weight Type							C.O.A.L.
		#1900	.284"	120gr.	SPT				2.750"
Powder	Velocity	2600	2700	2800	2900	3000	3050	3100	
IMR 8208 XBR				38.4	40.1	42.0			
H4895				37.9	39.5	41.3	42.3		
IMR 4895			38.2	40.0	41.7				
IMR 4166 End.			37.5	39.2	40.6				
IMR 4064			38.4	39.7	41.4				
RE 15				41.0	42.9	44.4	45.0		
N140			40.1	41.7	43.2	44.5			
Varget				40.5	42.4	44.1	45.0		
IMR 4320			38.3	40.2	42.0	43.6			
Win 748			39.6	41.1	42.7	44.4			
CFE 223					43.1	45.4	46.3	47.2	
Power Pro 2000 MR				43.7	45.3	47.0	47.8	48.7	
Big Game				43.1	44.9	46.7	47.6		
IMR 4350	44.4	45.7	47.2	48.7					
IMR 4451 End.	43.2	44.9	46.6	48.5					
RE 17		43.2	45.1	46.6	47.9	48.5	49.0		
<b>Energy Ft. Lbs</b>	<b>1801</b>	<b>1942</b>	<b>2089</b>	<b>2240</b>	<b>2398</b>	<b>2478</b>	<b>2560</b>		
Special Load	Powder	Grains	Velocity fps	Energy Ft. lb					
Accuracy Load	CFE 223	47.2	3100	2560					
Hunting Load	CFE 223	47.2	3100	2560					



# 7mm-08 Remington

Bullet		Caliber	Weight	Type	C.O.A.L.				
	#1903	.284"	130gr.	HPBT Match	2.780"				
Powder	Velocity	2450	2550	2650	2750	2850	2950	3000	
IMR 8208 XBR			36.6	38.0	39.5	41.1	42.7		
H4895			36.5	37.8	39.2	40.8	42.5		
IMR 4895			37.2	38.6	40.1	41.7			
IMR 4166 End.	35.5		37.0	38.4	39.9	41.3			
IMR 4064			37.9	39.3	40.8	42.4			
A 4064	35.1		36.8	38.5	40.0	41.4			
RE 15			38.6	40.1	41.6	43.0	44.3	45.0	
N140			38.9	40.7	42.3	43.8			
Varget			37.4	39.0	40.6	42.2	43.8		
IMR 4320			38.4	39.9	41.5	43.0	44.6		
Win 748			38.4	40.1	41.7	43.2	44.6		
CFE 223				40.7	42.5	44.3	46.1	47.0	
Power Pro 2000 MR			40.8	42.4	43.9	45.4	46.8	47.4	
Big Game				42.1	43.7	45.5	47.5	48.5	
Win 760			42.7	44.4	46.0	47.6	49.1	49.8	
IMR 4350			43.2	44.6	46.2	47.9	49.7		
IMR 4451 End.			43.2	44.6	46.3	48.0	49.9		
RE 16	41.2		42.3	43.6	45.1	46.8			
RE 17			41.9	43.5	44.9	46.4	47.7	48.4	
<b>Energy Ft. Lbs</b>			<b>1732</b>	<b>1877</b>	<b>2027</b>	<b>2183</b>	<b>2344</b>	<b>2512</b>	<b>2597</b>
Special Load	Powder	Grains	Velocity fps		Energy Ft. lb				
<b>Accuracy Load</b>	Win 760	49.8	3000		2597				
<i>Sierra does not recommend MatchKing bullets for hunting applications.</i>									

## 7mm-08 Remington

	Bullet	Caliber	Weight	Type	C.O.A.L.			
	#1905	.284"	140gr.	SBT	2.780"			
	#1910	.284"	140gr.	SPT	2.780"			
	#1912	.284"	140gr.	HPBT	2.740"			
Powder	Velocity	2300	2400	2500	2600	2700	2800	2900
IMR 8208 XBR			34.7	36.8	38.6	40.1	41.2	
H4895			34.2	35.8	37.4	39.2	41.0	
IMR 4166 End.		33.4	35.0	36.7	38.2	39.8	41.3	
A 4064			34.6	36.4	38.2	40.0		
RE 15				37.3	39.2	41.0	42.6	
N140			36.4	38.3	40.1	41.9		
Varget			35.3	37.0	38.6	40.3	42.0	
IMR 4320			36.4	37.9	39.4	41.0	42.6	
CFE 223				38.7	40.3	42.0	43.6	
Power Pro 2000 MR				39.2	40.7	42.3	44.0	45.8
Big Game					41.7	43.5	45.4	
Win 760				41.6	43.5	45.2	46.8	
IMR 4350			40.3	42.1	43.9	45.7	47.5	
IMR 4451 End.			41.3	42.9	44.6	46.4	48.2	
RE 16			39.3	41.0	42.8	44.5	46.4	
RE 17				40.7	42.6	44.2	45.8	47.2
<b>Energy Ft. Lbs</b>		<b>1644</b>	<b>1790</b>	<b>1943</b>	<b>2101</b>	<b>2266</b>	<b>2437</b>	<b>2614</b>
Special Load	Powder	Grains		Velocity fps	Energy Ft. lb			
<b>Accuracy Load</b>	H4895	41.0		2800	2437			
<b>Hunting Load</b>	Power Pro 2000 MR	45.8		2900	2614			



## 7mm-08 REMINGTON

	Bullet	Caliber	Weight	Type	C.O.A.L.
	#1913	.284"	150gr.	SBT	2.780"
	#1915	.284"	150gr.	HPBT Match	2.790"

Powder ∨	Velocity >	2200	2300	2400	2500	2600	2700	2800
H4895		33.4	35.0	36.6	38.2	39.9		
IMR 4166 End.		33.5	35.1	36.7	38.3	39.9		
RE 15		34.5	36.2	37.8	39.4	41.0		
N140		35.2	37.4	39.3	40.9			
Varget		34.0	35.6	37.3	39.0	40.7		
CFE 223		36.2	38.1	40.0	41.6	43.2		
Power Pro 2000 MR			38.5	40.3	42.0	43.5	45.0	
Big Game			38.6	40.4	42.3	44.2		
Win 760		39.2	40.8	42.3	43.9	45.4		
IMR 4350		39.0	40.7	42.4	44.2	46.0		
IMR 4451 End.		39.4	41.0	42.7	44.4	46.1		
H4350				41.8	43.7	45.5		
RE 16			39.6	41.2	42.9	44.7	46.6	
RE 17			39.4	41.2	42.9	44.3	45.6	
RE 19		42.6	43.8	45.2	46.8	48.6		
Hunter				43.0	45.0	47.4		
<b>Energy Ft. Lbs</b>		<b>1612</b>	<b>1762</b>	<b>1918</b>	<b>2081</b>	<b>2251</b>	<b>2428</b>	<b>2611</b>

Special Load	Powder	Grains	Velocity fps	Energy Ft. lb
<b>Accuracy Load</b>	Hunter	47.4	2700	2428
<b>Hunting Load</b>	Power Pro 2000 MR	45.0	2800	2611

# 7mm-08 Remington

	Bullet	Caliber	Weight	Type	C.O.A.L.
	#1920	.284"	160gr.	SBT	2.780"
	#1925	.284"	160gr.	HPBT	2.750"
	#7660	.284"	160gr.	TMK Match	2.800"



Powder ▾	Velocity >	2100	2200	2300	2400	2500	2600	2700
H4895		30.2	32.0	33.7	35.2	36.7		
IMR 4166 End.			32.1	33.8	35.4	37.0		
A 4064				33.8	35.8	37.5		
RE 15			33.3	34.9	36.6	38.2	39.7	
Varget			32.6	34.2	35.8	37.6	39.4	
CFE 223				36.3	38.1	39.9	41.7	
Power Pro 2000 MR			36.0	37.7	39.3	40.8	42.2	43.5
Big Game				37.3	39.1	40.9	42.7	
Win 760			37.7	39.5	41.1	42.6	43.9	
IMR 4350			37.6	39.1	40.7	42.5	44.5	
IMR 4451 End.				39.2	40.8	42.6	44.5	
H4350				38.6	40.4	42.0	43.6	45.0
RE 16					39.9	41.8	43.7	45.5
RE 17				38.0	39.7	41.3	42.8	44.2
RE 19				42.1	43.7	45.6	47.9	
Hunter					42.0	44.6	46.8	48.8
<b>Energy Ft. Lbs</b>		<b>1566</b>	<b>1719</b>	<b>1879</b>	<b>2046</b>	<b>2220</b>	<b>2401</b>	<b>2589</b>

Special Load	Powder	Grains	Velocity fps	Energy Ft. lb
<b>Accuracy Load</b>	RE 16	45.5	2700	2589
<b>Hunting Load</b>	Hunter	48.8	2700	2589



Sierra does not recommend MatchKing bullets for hunting applications.

## 7mm-08 Remington



		Bullet	Caliber	Weight	Type	C.O.A.L.			
	#1930	.284"	168gr.	HPBT	Match	2.800"			
	#4565	.284"	165gr.	TGK		2.800"			
Powder	Velocity	2100	2200	2300	2400	2500	2600	2700	
H4895		30.8	32.7	34.4	36.0	37.5			
IMR 4166 End.		30.9	32.5	34.1	35.7	37.2			
IMR 4064		31.8	33.4	34.9	36.5	38.0			
RE 15			33.9	35.5	37.2	39.0	40.7		
Varget		31.4	33.0	34.7	36.3	37.9			
CFE 223			35.7	37.7	39.5	41.1			
Power Pro 2000 MR			36.4	38.2	39.9	41.6	43.2		
Big Game				37.2	39.0	40.8	42.6		
Win 760		36.1	37.8	39.4	40.9	42.5	43.9		
IMR 4350		36.0	37.6	39.3	40.9	42.7			
IMR 4451 End.				39.2	41.2	43.1	45.1		
H4350				38.4	40.1	41.9	43.8		
RE 16				38.8	40.5	42.2	44.0		
RE 17			36.4	38.3	40.0	41.6	43.0		
RE 19				42.4	44.0	45.7	47.3	48.8	
Hunter						43.6	45.9	48.3	
<b>Energy Ft. Lbs</b>		<b>1615</b>	<b>1773</b>	<b>1938</b>	<b>2110</b>	<b>2289</b>	<b>2476</b>	<b>2670</b>	
Special Load	Powder	Grains	Velocity	fps	Energy	Ft. lb			
<b>Accuracy Load</b>	Win 760	43.9	2600		2476				
<b>Hunting Load</b>	RE 19	48.8	2700		2670				
<i>Sierra does not recommend MatchKing bullets for hunting applications.</i>									



## 7mm-08 REMINGTON

	Bullet	Caliber	Weight	Type					C.O.A.L.
	#1940	.284"	175gr.	SBT					2.800"
	#1975	.284"	175gr.	HPBT Match					2.900"*
*requires 1 x 8.5" twist or faster twist									
Powder	Velocity	2000	2100	2200	2300	2400	2500	2600	
H4895			31.1	32.6	34.2	35.9			
IMR 4064		31.0	32.4	33.9	35.3	36.8			
RE 15			32.0	33.5	35.1	36.9	38.7		
Varget		30.4	32.0	33.5	35.2	36.8			
CFE 223				35.2	37.3	39.3	41.1		
Power Pro 2000 MR				36.4	38.2	39.9	41.6	43.2	
Big Game				35.4	37.5	39.5	41.5		
N540			32.6	34.2	35.9	37.7	39.5		
Win 760				38.3	40.0	41.6	43.0		
IMR 4350			35.8	37.4	39.1	40.9	42.7		
IMR 4451 End.				38.3	40.0	41.6	43.2		
H4350			36.0	37.3	38.8	40.6	42.7		
RE 16					38.5	40.3	42.2	43.9	
RE 17					38.1	39.9	41.6	43.1	
RE 19		40.0	40.7	41.6	42.7	44.1	45.6	47.4	
Hunter					40.1	42.3	44.5	46.7	
<b>Energy Ft. Lbs</b>		<b>1554</b>	<b>1713</b>	<b>1880</b>	<b>2055</b>	<b>2238</b>	<b>2428</b>	<b>2626</b>	
Special Load	Powder	Grains		Velocity fps	Energy Ft. lb				
<b>Accuracy Load</b>	RE 15	38.7		2500	2428				
<b>Hunting Load</b>	Power Pro 2000 MR	43.2		2600	2626				
<i>Sierra does not recommend MatchKing bullets for hunting applications.</i>									

## 7mm-08 Remington

Bullet	Caliber	Weight	Type	C.O.A.L.				
	#1980	.284"	180gr. HPBT Match	2.910"*				
	#1983	.284"	183gr. HPBT Match	3.000"*				
*requires 1 x 8" twist or faster twist								
Powder	Velocity	2000	2100	2200	2300	2400	2500	2600
RE 15			32.2	33.9	35.6	37.4	39.3	
Target		31.0	32.4	33.9	35.4	36.9		
Power Pro 2000 MR				36.6	38.2	39.9	41.5	
Big Game			34.8	36.4	38.1	39.9	41.8	
Win 760		35.7	37.5	39.2	40.8	42.1	43.3	
IMR 4350			36.0	37.4	39.2	41.4		
IMR 4451 End.				38.2	39.8	41.6		
H4350				37.0	38.5	40.5	42.9	
RE 16				37.0	38.9	40.9	42.8	
RE 17			35.3	37.1	38.8	40.5	42.0	
RE 19				41.0	42.9	44.8	46.5	48.1
Hunter					40.3	42.4	44.7	
<b>Energy Ft. Lbs</b>		<b>1598</b>	<b>1762</b>	<b>1934</b>	<b>2114</b>	<b>2302</b>	<b>2498</b>	<b>2701</b>
Special Load	Powder	Grains	Velocity fps	Energy Ft. lb				
<b>Accuracy Load</b>	RE 16	42.8	2500	2498				
<i>Sierra does not recommend MatchKing bullets for hunting applications.</i>								

# 7mm-08 REMINGTON

Bullet		Caliber	Weight	Type	C.O.A.L.					
		#1997	.284"	197gr.	HPBT Match	3.100"*				
*requires 1 x 7.5" twist or faster twist										
Powder	Velocity	1950	2050	2150	2250	2300	2350	2400		
Target		30.4	32.0	33.6	35.3	36.1				
Power Pro 2000 MR			34.5	36.3	38.0	38.9	39.8	40.6		
Big Game		32.2	33.8	35.5	37.3	38.2	39.1			
Win 760		34.0	36.0	37.8	39.7	40.6	41.4			
IMR 4350		34.4	36.0	37.7	39.4	40.2	41.1			
IMR 4451 End.		34.3	36.0	37.7	39.5	40.4	41.4	42.3		
H4350			35.4	37.1	38.9	39.8	40.7	41.6		
RE 16				36.8	38.6	39.5	40.5	41.4		
RE 17			34.3	35.9	37.5	38.4	39.3	40.2		
RE 19				40.2	41.9	42.8	43.8	44.7		
Hunter				38.2	40.0	41.0	42.1	43.2		
H4831sc			38.2	39.7	41.4	42.4	43.5	44.6		
H1000				42.4	44.1	45.1	46.0	47.1		
<b>Energy Ft. Lbs</b>		<b>1663</b>	<b>1838</b>	<b>2022</b>	<b>2214</b>	<b>2314</b>	<b>2415</b>	<b>2519</b>		
Special Load	Powder	Grains	Velocity	fps	Energy	Ft. lb				
<b>Accuracy Load</b>	H4350	41.6	2400		2519					
<i>Sierra does not recommend MatchKing bullets for hunting applications.</i>										