

# 28 NOSLER

## Test Specifications:

Firearm Used: Universal

Barrel Length: 24"

Twist: 1 - 9"

## Components:

Case: Nosler

Trim-to Length: 2.570"

Primer: WLRM

## Remarks:

When the 26 Nosler appeared in 2013, many people asked: "What will they neck it to next?" The best guesses were a 7mm or a .30 cal., and the former turned out to be right. Of course, many of the same people then asked, "Why bother?" since the list of 7mm big game rounds compares to the Fortune 500. Such skepticism is apparently normal in the Internet age, when shooters all over the world can anonymously post their sophisticated doubts.

The primary accomplishment of the 28 Nosler is to match the velocities of longer belted 7mm magnums, but in a case that fits inside "30-06 length," magazines. I experimented extensively with one of the first 28 Nosler rifles, a Model 48 Liberty with a 26 inch barrel, and with bullets from 150-175 grains, it matched or beat the velocities of most other commercial 7mm magnums, with excellent accuracy.

The extra bullet weight over the 26 Nosler provides a level of comfort for the many hunters who firmly believe in bigger bullets for bigger game, in a round that will fit and feed in just about any commercial action designed around such common belted cases as the 7mm Remington Magnum and .300 Winchester Magnum. That alone is worth something, but Nosler's cases also proved very uniform, contributing to the excellent accuracy. Since then, the 28 Nosler has proven itself many times in big game hunting around the world, and its popularity probably rivals the 26.

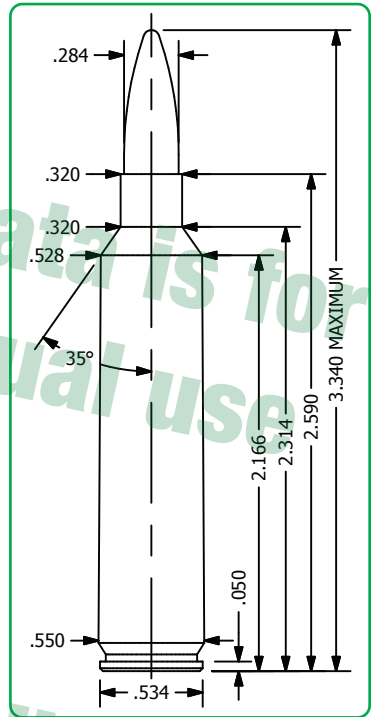





**Z8 NOSLER**

		Bullet Caliber Weight Type							C.O.A.L.
		#1900	.284"	120gr.	SPT				3.250"
Powder ▾	Velocity >	3200	3250	3300	3350	3400	3450	3500	
IMR 7828ssc		79.4	81.0	82.3	83.5	84.4			
IMR 7977 End.		83.2	84.3	85.2	86.1	86.9	87.7		
H1000		81.0	82.6	84.1	85.5	86.7	87.9		
RE 26				79.9	81.4	82.9	84.3	85.5	
Magnum		84.4	85.7	87.1	88.4	89.9	91.4		
Retumbo		82.9	84.3	85.6	86.9	88.3	89.6		
US869		99.1	100.3						
<b>Energy Ft. Lbs</b>		<b>2728</b>	<b>2814</b>	<b>2901</b>	<b>2990</b>	<b>3080</b>	<b>3171</b>	<b>3264</b>	
Special Load	Powder	Grains	Velocity fps	Energy Ft. lb					
<b>Accuracy Load</b>	Retumbo	89.6	3450	3171					
<b>Hunting Load</b>	RE 26	85.5	3500	3264					

Do not edit or  
redistribute.

# 28 NOSLER

	Bullet	Caliber	Weight	Type	C.O.A.L.			
	#1903	.284"	130gr.	HPBT Match	3.225"			
	#1905	.284"	140gr.	SBT	3.260"			
	#1910	.284"	140gr.	SPT	3.260"			
	#1912	.284"	140gr.	HPBT	3.225"			



Powder ∨	Velocity >	2900	2950	3000	3050	3100	3150	3200
IMR 7828ssc		73.1	74.5	75.8	77.1	78.5	79.8	
IMR 7977 End.		77.4	78.7	79.9	81.1	82.2	83.3	84.4
H1000			75.6	77.2	78.9	80.4	81.9	83.2
RE 26				74.3	75.7	77.1	78.5	80.0
Magnum			78.4	79.7	81.1	82.6	84.1	85.8
Retumbo			77.8	79.6	81.3	82.8	84.1	85.3
RE 33				85.2	86.5	87.9	89.3	90.7
US869		92.1	93.4	94.6	95.8	97.0		
<b>Energy Ft. Lbs</b>		<b>2427</b>	<b>2512</b>	<b>2597</b>	<b>2685</b>	<b>2774</b>	<b>2864</b>	<b>2955</b>

Special Load	Powder	Grains	Velocity fps	Energy Ft. lb
<b>Accuracy Load</b>	Retumbo	85.3	3200	2955
<b>Hunting Load</b>	IMR 7977 End.	84.4	3200	2955

*Sierra does not recommend MatchKing bullets for hunting applications.*

# Z8 NOSLER

Bullet	Caliber	Weight	Type	C.O.A.L.
	#1913	.284"	150gr. SBT	3.300"
	#1915	.284"	150gr. HPBT Match	3.300"



Powder	Velocity	2900	2950	3000	3050	3100	3150	3200
IMR 7828ssc		72.9	74.0	75.2	76.2	77.3		
IMR 7977 End.		76.1	77.1	78.2	79.2	80.2	81.2	
H1000			75.5	77.1	78.6	80.1	81.4	82.7
RE 26			73.6	75.0	76.4	77.7	79.1	80.3
Magnum		77.9	79.3	80.7	82.1	83.4	84.8	
Retumbo		74.7	75.8	77.0	78.2	79.4	80.7	82.0
RE 33		83.9	85.3	86.6	87.9	89.2	90.4	91.5
US869		90.1	91.6	93.1	94.5	95.9		
<b>Energy Ft. Lbs</b>		<b>2801</b>	<b>2898</b>	<b>2997</b>	<b>3098</b>	<b>3200</b>	<b>3304</b>	<b>3410</b>

Special Load	Powder	Grains	Velocity fps	Energy Ft. lb
<b>Accuracy Load</b>	Retumbo	82.0	3200	3410
<b>Hunting Load</b>	H1000	82.7	3200	3410

*Sierra does not recommend MatchKing bullets for hunting applications.*

# 28 Nosler

Bullet	Caliber	Weight	Type	C.O.A.L.
	#1920	.284"	160gr. SBT	3.245"
	#1925	.284"	160gr. HPBT	3.200"
	#7660	.284"	160gr. TMK Match	3.340"

Powder	Velocity	2800	2850	2900	2950	3000	3050	3100
IMR 7977 End.		73.4	74.4	75.5	76.6	77.8	79.1	80.4
H1000		71.3	72.7	74.1	75.5	76.8	78.2	79.6
RE 26			71.0	72.0	73.1	74.4	75.7	77.2
Magnum			76.3	77.6	79.0	80.3	81.7	83.1
Retumbo			73.9	75.2	76.6	77.9	79.3	80.6
RE 33				83.2	84.4	85.7	87.0	88.3
US869					91.3	92.9	94.3	95.8
<b>Energy Ft. Lbs</b>		<b>2785</b>	<b>2885</b>	<b>2987</b>	<b>3091</b>	<b>3197</b>	<b>3304</b>	<b>3414</b>





  

Special Load	Powder	Grains	Velocity fps	Energy Ft. lb
<b>Accuracy Load</b>	IMR 7977 End.	80.4	3100	3414
<b>Hunting Load</b>	Magnum	83.1	3100	3414

Sierra does not recommend MatchKing bullets for hunting applications.

Do not edit or redistribute.

# 78 Nosler

Bullet	Caliber	Weight	Type	C.O.A.L.
	#4565	.284"	165gr. TGK	3.340"
	#1930	.284"	168gr. HPBT Match	3.340"
	#1940	.284"	175gr. SBT	3.300"
	#1975	.284"	175gr. HPBT Match	3.340"*
*requires 1 x 8.5" twist or faster twist				



Powder ▾	Velocity >	2700	2750	2800	2850	2900	2950	3000
IMR 7977 End.		72.8	74.0	75.2	76.4	77.6	78.8	
H1000			71.1	72.9	74.6	76.1		
RE 26				68.0	69.6	71.3	73.1	
Magnum		74.6	76.2	77.7	79.1	80.3	81.3	82.2
Retumbo				71.4	72.9	74.5	76.4	78.3
RE 33					76.4	78.7	80.9	83.0
US869				87.9	89.4	90.9	92.4	94.0
<b>Energy Ft. Lbs</b>		<b>2670</b>	<b>2770</b>	<b>2872</b>	<b>2975</b>	<b>3081</b>	<b>3188</b>	<b>3297</b>

Special Load	Powder	Grains	Velocity fps	Energy Ft. lb
<b>Accuracy Load</b>	H1000	76.1	2900	3081
<b>Hunting Load</b>	Magnum	82.2	3000	3297

Sierra does not recommend MatchKing bullets for hunting applications.

# 28 Nosler

Bullet	Caliber	Weight	Type	C.O.A.L.					
	#1980	.284"	180gr.	HPBT Match	3.340"*				
	#1983	.284"	183gr.	HPBT Match	3.340"*				
*requires 1 x 8" twist or faster twist									
Powder	Velocity	2625	2675	2725	2775	2825	2875	2900	
IMR 7977 End.		70.6	72.4	74.0	75.3	76.4	77.2	77.5	
H1000				70.9	72.6	74.2	75.6	76.3	
RE 26				68.2	70.4	72.3	73.6	74.2	
Magnum				74.7	76.8	78.5	80.0	80.5	
Retumbo				73.1	74.6	75.9	77.3	78.0	
RE 33				78.1	79.7	81.2	82.6	83.2	
US869			84.5	85.7	87.0	88.4	89.8	90.5	
<b>Energy Ft. Lbs</b>		<b>2754</b>	<b>2859</b>	<b>2967</b>	<b>3077</b>	<b>3189</b>	<b>3303</b>	<b>3361</b>	
Special Load	Powder	Grains	Velocity fps	Energy Ft. lb					
<b>Accuracy Load</b>	Retumbo	78.0	2900	3361					
<i>Sierra does not recommend MatchKing bullets for hunting applications.</i>									

Do not edit or redistribute.

**Z8 NOSLER**

		Bullet Caliber Weight Type							C.O.A.L.
		#1997 .284" 197gr. HPBT Match							3.340"
		*requires 1 x 7.5" twist or faster twist							
Powder ∨	Velocity >	2600	2650	2700	2750	2800	2850	2900	
H1000			69.2	71.6	76.0				
RE 26		67.7	69.0	70.4	71.9				
Magnum		73.1	74.6	76.1	77.5	78.8			
Retumbo		72.0	73.4	74.8	76.0	77.3	78.4		
RE 33				80.5	81.9	83.1	84.1	85.0	
US869				84.0	85.2	86.9	89.1	91.9	
<b>Energy Ft. Lbs</b>		<b>2957</b>	<b>3071</b>	<b>3188</b>	<b>3307</b>	<b>3429</b>	<b>3552</b>	<b>3678</b>	
Special Load	Powder	Grains		Velocity fps	Energy Ft. lb				
<b>Accuracy Load</b>	RE 26	71.9		2750	3307				
<i>Sierra does not recommend MatchKing bullets for hunting applications.</i>									

Do not edit or  
redistribute.