

6.5 CREEDMOOR

Test Specifications:

Firearm Used: Universal

Barrel Length: 24"

Twist: 1-8"

Components:

Case: Hornady

Trim-to Length: 1.910"

Primer: WLR

Remarks:

Developed in 2007 by Dennis DeMille and Dave Emary, the 6.5 Creedmoor is a shortened and improved 30 TC cartridge case that was inspired by the .308 Winchester design. This short action design was created to maximize case capacity and a wide range of loading lengths, while still fitting in standard short action magazines. With the correct twist barrel, the versatile 6.5 Creedmoor can take advantage of the wide range of bullet weights available in 6.5mm. Reloaders should keep in mind that the 6.5 Creedmoor works best with medium to medium-slow powders such as H4350, Varget, Win 760, and RE-17. The light recoil and adaptability of the efficient 6.5 Creedmoor cartridge has already proven itself in high power, precision rifle series and benchrest competitions. Couple that with respectable barrel life and its intrinsic accuracy potential and you have a recipe for success which should insure its legacy for decades to come.

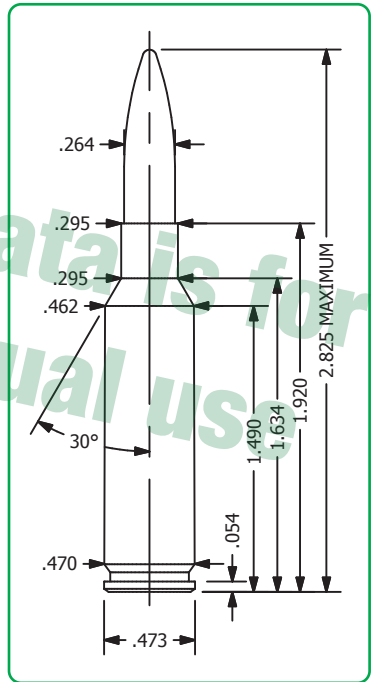



6.5 CREEDMOOR

Bullet		Caliber	Weight	Type	C.O.A.L.				
	#1700	.264"	85gr.	HP	2.670"				
Powder	Velocity	2900	3000	3100	3200	3300	3400	3500	
IMR 8208 XBR				39.1	40.4	41.5	42.6		
TAC				39.5	41.0	42.3			
IMR 4895		38.5	39.9	41.2	42.4				
IMR 4166 End.		38.3	39.6	40.9	42.2	43.4			
IMR 4064				40.3	41.7	43.1	44.4		
RE 15				41.0	42.2	43.4	44.6	45.8	
Varget		39.1	40.6	41.9	43.2				
Power Pro 2000 MR				43.3	44.6	45.9	47.2	48.6	
Win 760				45.5	47.0				
H4350		43.2	44.5	45.9	47.2				
RE 17			43.4	44.4	45.5	46.7	48.0		
Energy Ft. Lbs		1587	1698	1813	1932	2055	2181	2312	
Special Load	Powder	Grains	Velocity fps	Energy Ft. lbs					
Accuracy Load	IMR 4895	42.4	3300	2055					
Hunting Load	RE 15	45.8	3500	2312					



Do not edit or redistribute.

6.5 CREEDMOOR

Bullet		Caliber	Weight	Type						C.O.A.L.
	#1710	.264"	100gr.	HP						2.650"
	#1711	.264"	100gr.	HPBT						2.650
Powder	Velocity	> 2850	2950	3050	3150	3200	3250	3300		
N133			37.3	39.0						
IMR 8208 XBR			38.2	39.6	41.2	42.1				
IMR 4895			39.5	41.0	42.4					
IMR 4064			39.6	40.9	42.4					
RE 15			40.1	41.9	43.1	43.6				
Varget				40.9	42.5	43.3				
Power Pro 2000 MR			42.8	44.1	45.4	46.1	46.8	47.5		
RE 17	42.1	43.7	45.1	46.3	46.8	47.4	47.8			
Energy Ft. Lbs		1803	1932	2065	2203	2273	2345	2418		
Special Load	Powder	Grains		Velocity fps	Energy Ft. lbs					
Accuracy Load	RE 15	43.6		3200	2273					
Hunting Load	Power Pro 2000 MR	47.5		3300	2418					

Do not edit or redistribute.

6.5 CREEDMOOR



Bullet	Caliber	Weight	Type	C.O.A.L.
	#1715	.264"	107gr. HPBT Match	2.790"
	#7407	.264"	107gr. TMK	2.790"

Powder	Velocity	2700	2800	2900	3000	3100	3150	3200
IMR 8208 XBR				37.6	38.9	40.4		
H4895				37.5	39.0	40.5		
IMR 4895			37.2	38.6	39.8			
IMR 4064	36.0	37.3	38.6	40.0				
RE 15			39.2	40.6	41.9	42.4		
Varget			38.6	39.9	41.5	42.4		
Win 760		42.8	44.2	45.5	46.7	47.3		
IMR 4451 End.		43.2	44.6	45.9				
RE 17		41.3	42.6	43.8	45.0	45.5	46.0	
Energy Ft. Lbs		1732	1862	1998	2138	2283	2357	2432

Special Load	Powder	Grains	Velocity fps	Energy Ft. lbs
Accuracy Load	H4895	40.5	3100	2283
Hunting Load	RE 17	46.0	3200	2432

Sierra does not recommend MatchKing bullets for hunting applications.



6.5 CREEDMOOR

		Bullet Caliber Weight Type							C.O.A.L.
	#1725	.264"	120gr.	HPBT Match					2.750"
	#1720	.264"	120gr.	SPT					2.730"
Powder	Velocity	2600	2700	2800	2850	2900	2950	3000	
IMR 8208 XBR		33.7	35.6						
H4895		34.7	36.3	37.9	38.7	39.5			
IMR 4895		34.4	36.0	37.5					
RE 15			36.6	38.4	39.2	40.1			
Win 760				42.8	43.7	44.6	45.4		
IMR 4350			41.6	43.4	44.2	44.9			
IMR 4451 End.			41.2	43.0	43.9	44.8			
H4350				42.0	43.1	44.0	44.7		
RE 17			39.1	40.9	41.7	42.4	43.1	43.7	
Hybrid 100V		38.2	40.1	41.7	42.5	43.2			
Energy Ft. Lbs		1801	1942	2089	2164	2240	2318	2398	
Special Load	Powder	Grains	Velocity fps	Energy Ft. lbs					
Accuracy Load	IMR 4451 End.	44.8	2900	2240					
Hunting Load	RE 17	43.7	3000	2398					
<i>Sierra does not recommend MatchKing bullets for hunting applications.</i>									



6.5 CREEDMOOR

Bullet		Caliber	Weight	Type	C.O.A.L.					
		#1727	.264"	123gr.	HPBT Match	2.795"				
Powder	Velocity	2550	2650	2750	2850	2900	2950	3000		
IMR 8208 XBR			35.1	36.7	38.2					
H4895	34.1	35.2	36.5	38.1	39.0					
IMR 4895		35.8	37.2	38.6						
IMR 4064		36.2	37.6	39.2						
RE 15			37.8	39.5	40.2	41.0				
Varget			37.2	38.8	39.6					
Win 760				43.9	44.8	45.5	46.2			
IMR 4350		40.5	42.0	43.5	44.4					
IMR 4451 End.			42.8	43.9	44.5	45.3				
H4350			42.2	44.5	45.2	45.6				
RE 17		38.1	40.0	41.7	42.5	43.1	43.8			
Hybrid 100V		39.1	40.6	42.2	42.9	43.7				
Energy Ft. Lbs		1776	1918	2065	2218	2297	2376	2458		
Special Load	Powder	Grains	Velocity fps	Energy Ft. lbs						
Accuracy Load	H4895	39.0	2900	2297						
<i>Sierra does not recommend MatchKing bullets for hunting applications.</i>										

6.5 CREEDMOOR

	Bullet	Caliber	Weight	Type	C.O.A.L.			
	#1728	.264"	130gr.	HPBT	2.670"			
	#7430	.264"	130gr.	TMK Match	2.810"*			
	#4330	.264"	130gr.	TGK	2.810"*			
*requires a 1x8" or faster twist								
Powder	Velocity	2350	2450	2550	2650	2750	2850	2900
H4895				34.4	35.8	37.4		
IMR 4895				35.1	36.6	38.0		
IMR 4064			34.0	35.2	36.6	38.3		
RE 15				35.3	37.1	38.7	40.3	
Varget				35.2	36.9	38.3		
Win 760				40.1	41.5	42.9	44.3	44.9
IMR 4350					41.9	43.4		
IMR 4451 End.				39.9	41.5	43.1	44.6	
H4350					40.5	42.1	43.8	
RE 16					40.3	41.9	43.5	44.3
RE 17					39.7	41.2	42.5	43.1
AR Comp			32.2	33.7	35.4			
Hybrid 100V				38.1	39.6	41.2		
RE 19			41.1	42.3	43.7	45.1	46.7	
IMR 4955 End.	37.6	39.0	40.8					
RE 22		41.8	43.1	44.7	46.5			
Energy Ft. Lbs		1594	1732	1877	2027	2183	2344	2427
Special Load	Powder	Grains	Velocity fps	Energy Ft. lbs				
Accuracy Load	AR Comp	35.4	2650	2027				
Hunting Load	Win 760	44.9	2900	2427				
<i>Sierra does not recommend MatchKing bullets for hunting applications.</i>								

6.5 CREEDMOOR

	Bullet	Caliber	Weight	Type	C.O.A.L.				
	#1730	.264"	140gr.	SBT					2.750"
	#1740	.264"	140gr.	HPBT Match					2.810"
	#1742	.264"	142gr.	HPBT Match					2.810"*
*requires a 1x8" or faster twist									
Powder	Velocity	2300	2400	2500	2600	2700	2800	2900	
H4895			32.7	34.2	35.8				
IMR 4895		32.1	33.5	35.0	36.6				
IMR 4064		32.3	33.9	35.4	36.9				
RE 15				35.6	37.5	38.8			
Varget			33.6	35.2	36.8				
Big Game					39.4	41.2			
IMR 4350				39.2	40.7	42.4			
IMR 4451 End.				39.9	41.4	42.9			
H4350				39.2	40.4	41.9			
RE 16					40.2	42.0	43.5		
RE 17				37.6	38.9	40.4	42.1		
Hybrid 100V					39.8	41.5			
RE 19				41.8	43.2	44.7	46.5		
H4831sc					43.6	45.6			
Superformance						44.7	46.0	47.4	
Energy Ft. Lbs		1644	1790	1943	2101	2266	2437	2614	
Special Load	Powder	Grains	Velocity fps	Energy Ft. lbs					
Accuracy Load	Varget	36.8	2600	2101					
Hunting Load	Superformance	47.4	2900	2614					
<i>Sierra does not recommend MatchKing bullets for hunting applications.</i>									

6.5 CREEDMOOR

Bullet		Caliber	Weight	Type	C.O.A.L.					
		#1755	.264"	150gr.	HPBT Match	2.810"*				
*requires a 1x7.5" or faster twist										
Powder	Velocity	2250	2350	2450	2550	2650	2750	2800		
RE 15			33.1	34.9	36.8					
N540		32.2	33.6	35.2	37.0					
IMR 4350			37.1	38.9	40.6					
IMR 4451 End.			37.3	38.8	40.4	42.1				
H4350			36.1	37.8	39.6	41.3				
RE 16				38.1	39.8	41.7				
RE 17				37.2	38.8	40.3				
Hybrid 100V				37.2	39.1	40.6				
RE 19			40.2	41.7	43.3	44.9	46.5			
H4831sc			39.2	40.9	42.9	44.9				
Superformance				41.1	42.5	44.0	45.6	46.5		
H1000			41.6	43.5	45.9					
Energy Ft. Lbs		1686	1839	1999	2165	2339	2518	2611		
Special Load	Powder	Grains	Velocity	fps	Energy	Ft. lbs				
Accuracy Load	Hybrid 100V	40.6	2650		2339					
<i>Sierra does not recommend MatchKing bullets for hunting applications.</i>										

6.5 Creedmoor

Test Specifications:

Firearm Used: Universal Receiver

Barrel Length: 24"

Twist: 1x8"

Components:

Case: Starline

Trim-to-Length: 1.910"

Primer: Federal 210

Remarks:

Empty space for handwritten remarks.



INDICATES MAXIMUM LOAD - USE CAUTION
LOADS LESS THAN MINIMUM CHARGES SHOWN ARE NOT ED.

6.5 Creedmoor

62,000 'PSI

Bullet	Caliber	Weight	Type	C.O.A.L.
#4330	0.264	130gr	TGK	2.780"*

* Requires an 1-8 Twist

Powder	Velocity >	2550	2650	2750	2800	2850	2875	2925
SW Creed		35.2	36.9	38.3				
RS Big Game		36.1	37.8	39.5	40.7			
PP 4000MR			40.1	41.8	42.6	43.5	43.7	
W 760			38.4	39.9	40.7	41.5		
IMR 4350			38.8	40.4	41.2	42.1		
H 4350			38.0	39.8	40.9			
A 4350			39.5	41.5	42.5	43.3		
SW 4350	40.9		42.5	44.1				
Staball 6.5			40.0	41.5	42.3	43.1	43.5	44.2
RS Hunter			41.8	43.7	44.6	45.4		
N 555			40.2	42.1	43.2			
Energy Ft. Lbs		1877	2027	2183	2263	2344	2386	2469

Special Load	Powder	Grains	Velocity fps	Energy Ft. Lbs
Accuracy Load	N 555	42.7	2781	2232
Hunting Load	PP 4000MR	43.5	2852	2348

Sierra does not recommend MatchKing bullets for hunting applications.



INDICATES MAXIMUM LOAD - USE CAUTION
LOADS LESS THAN MINIMUM CHARGES SHOWN ARE NOT RECOMMENDED.

6.5 Creedmoor

62,000 'PSI

Bullet	Caliber	Weight	Type	C.O.A.L.
#4340	0.264	140gr	TGK	2.780"*

* Requires an 1-8 Twist

Powder	Velocity >	2500	2600	2650	2700	2750	2775	2800
SW The Creed		35.6	37.2	37.5				
RS Big Game		36.2	37.9	38.7	39.2			
PP 4000mr			40.2	41.0	41.8	42.6	43.0	43.3
W 760		37.3	38.8	39.5	40.2			
IMR 4350		37.0	38.6	39.5	40.3	40.7		
R-16		36.9	38.6	39.4	40.2	40.7		
H 4350		36.2	37.9	38.7	39.6			
A 4350			40.3	41.2	42.1	43.1		
Staball 6.5		38.9	40.3	40.9	41.6	42.3	42.6	42.9
N 555		38.8	40.5	41.4	42.2	43.1		
SW 4350		40.5	42.0	42.8	43.5			
N 560		41.7	43.5	44.3	44.8			
Energy Ft. Lbs		1943	2101	2183	2266	2351	2394	2437

Special Load	Powder	Grains	Velocity fps	Energy Ft. Lbs
Accuracy Load	R-16	40	2702	2269
Hunting Load	Staball 6.5	42.7	2778	2399

Sierra does not recommend MatchKing bullets for hunting applications.



INDICATES MAXIMUM LOAD - USE CAUTION
LOADS LESS THAN MINIMUM CHARGES SHOWN ARE NOT RECOMMENDED.

6.5 Creedmoor

62,000 'PSI

Bullet	Caliber	Weight	Type	C.O.A.L.
#4345	0.264	145gr	TGK	2.780"*

* Requires an 1-8 Twist

Powder	Velocity >	2475	2500	2525	2575	2625	2650	2700
W 760		37.5	37.9	38.3	38.8			
IMR 4350		37.4	37.8	38.2	39.0			
H 4350		36.0	36.5	37.2				
A 4350		38.9	39.4	39.9	40.8	41.8	42.2	43.0
SW 4350		40.4	40.8	41.5				
Staball 6.5		38.3	38.7	39.1	39.9	40.6		
Superformance		40.1	40.4	40.7	41.4	42.1	42.4	43.1
IMR 4831		39.6	40.1					
RS Hunter		39.9	40.3	40.8	41.9			
N555		37.8	38.3	38.8	41.9			
N 560		41.7	42.2	42.6	43.9			
Energy Ft. Lbs		1972	2012	2053	2135	2218	2261	2347

Special Load	Powder	Grains	Velocity fps	Energy Ft. Lbs
Accuracy Load	N 555	40	2599	2175
Hunting Load	A 4350	42.7	2675	2304

Sierra does not recommend MatchKing bullets for hunting applications.



INDICATES MAXIMUM LOAD - USE CAUTION
LOADS LESS THAN MINIMUM CHARGES SHOWN ARE NOT RECOMMENDED.

6.5 Creedmoor

62,000 'PSI

Bullet	Caliber	Weight	Type	C.O.A.L.
#7450	0.264	153gr	TMK	2.780"*

* Requires an 1-7.5 Twist

Powder	Velocity >	2475	2500	2550	2600	2625	2650	2675
IMR 4350		37.9	38.3	39.2	40.1	40.5		
H 4350		36.9	37.3	38.2	39.2			
R-17		36.4	36.8	37.5	38.3	38.7	39.1	
A 4350		38.9	39.4	40.4	41.4	41.8		
SW 4350		41.0	41.4	42.1				
Staball 6.5			39.8	40.6	41.3	41.7	42.1	42.5
N555		38.6	39.1	40.1	41.1	41.5		
Energy Ft. Lbs		2081	2123	2209	2296	2341	2386	2431

Special Load	Powder	Grains	Velocity fps	Energy Ft. Lbs
Accuracy Load	A 4350	41.6	2615	2323
Hunting Load	Staball 6.5	42.0	2640	2368

Sierra does not recommend MatchKing bullets for hunting applications.



INDICATES MAXIMUM LOAD - USE CAUTION
LOADS LESS THAN MINIMUM CHARGES SHOWN ARE NOT RECOMMENDED.