

6mm CREEDMOOR

Test Specifications:

Firearm Used: Universal

Barrel Length: 24"

Twist: 1- 8"

Components:

Case: Hornady

Trim-to Length: 1.910"

Primer: WLR

Remarks:

The spanking-new 6mm Creedmoor was spawned from the hugely-popular 6.5 Creedmoor, and soon became a darling in the high-speed shooting sport of PRC (Precision Rifle Series). It was brought to fruition by Outdoor Life firearms columnist John Snow, gunmaker George Gardner (GA Precision) and Hornady Manufacturing. SAAMI accepted the round in 2017, though it had been a popular wildcat option soon after the 6.5 Creedmoor's release in 2008. Initially the 6mm Creedmoor was chambered in AR-10 rifles by PRC enthusiasts, later chassis rifles such as the Ruger Precision Rifle, but its flat trajectory, inherent wind-bucking abilities and tame recoil inspired its spread into other rifle-action types.

Outwardly a ballistic twin to the venerable .243 Winchester, several factors nonetheless set the 6mm Creedmoor apart. Largest amongst these is current 6mm Creedmoors include faster rifling twists (1-in-7.7-inch for Ruger's Precision Rifle vs. 1-in-10 for .243 Wins, for example) so they thrive on long-for-caliber bullets with high ballistic coefficients for superior long-range performance. The Creedmoor also includes a maximum average pressure of 62,000 psi to the .243's 60,000 psi, while its 30-degree shoulder has proven highly efficient producing low extreme velocity spreads and prolongs brass life, its longer neck more consistently anchoring longer bullets.

Brass is easily formed from 6.5 Creedmoor cases via sizing and trimming, though Hornady and Lapua currently offer properly headstamped cases, with more brands sure to follow. Factory- ammo giants such as Hornady, Barnes, Remington and Federal have jumped on board, offering loaded rounds for sighting and target practice, and once-fired cases to save against future load development.

Typical 6mm Creedmoor rifling twists produce excellent accuracy in bullets down to 75-90 grains, but the cartridge really shines as a long-range performer when loaded with streamlined, long-for-caliber 95- to 107-grain pills. The 95-grain Tipped MatchKing has become a go-to long-range/windy-day "rockchuck" (yellow-bellied marmot) bullet, offering .500 BC and reliable expansion on impact. The 100-grain SBT offers a deadly deer-hunting option, while a 107-grain MatchKing allows banging 1,000-yard gongs with relative aplomb.

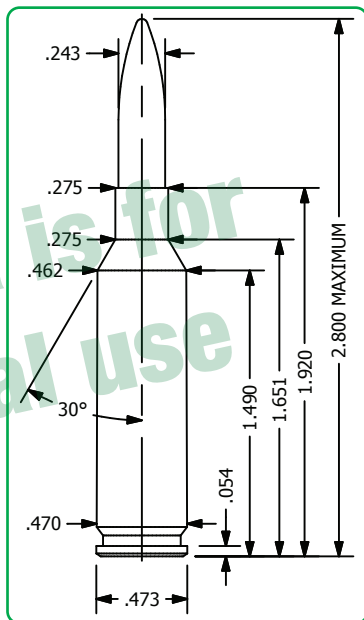

6mm CREEDMOOR

Bullet		Caliber	Weight	Type	C.O.A.L.				
	#1502	.243"	55gr.	BlitzKing	2.575"				
Powder	Velocity	3400	3500	3600	3700	3800	3900	4000	
IMR 3031		35.8	37.0	38.3	39.5	40.7	41.9		
Benchmark		37.1	37.9	38.8	39.9	41.1	42.5		
H4895		41.6	44.0						
IMR 4895		37.8	38.8	39.8	40.9	42.1	43.4		
IMR 4166 End.		37.6	38.5	39.5	40.6	41.8	43.1		
IMR 4064		38.5	39.6	40.6	41.7	42.8	43.9		
RE 15		39.2	40.6	41.9	43.0	44.1	45.0	45.9	
N140		40.3	41.3	42.3	43.3	44.2	45.2		
Varget		39.2	39.9	40.8	41.8	42.9	44.1	45.4	
Power Pro 2000 MR		42.5	43.6	44.7	45.9	47.0	48.2		
Energy Ft. Lbs		1412	1496	1582	1672	1763	1857	1954	
Special Load	Powder	Grains	Velocity fps	Energy Ft. lbs					
Accuracy Load	IMR 4064	43.9	3900	1857					
Hunting Load	Power Pro 2000 MR	48.2	3900	1857					





To date, the 6mm Creedmoor has remained most popular with long-range enthusiasts, largely chambered in modern chassis rifles that offer out-of-the-box accuracy often bettering 3/4 MOA, load development generally improving those numbers.



6mm CREEDMOOR

Bullet		Caliber	Weight	Type	C.O.A.L.			
		#1500	.243"	60gr.	HP	2.500"		
Powder	Velocity	3300	3400	3500	3600	3700	3800	
IMR 3031		36.2	37.3	38.4	39.5	40.6		
IMR 8208 XBR			37.0	38.3	39.6	40.9	42.4	
H4895		36.7	37.7	38.8	40.0	41.2	42.5	
IMR 4895		37.3	38.2	39.2	40.4	41.5		
IMR 4166 End.		36.8	38.0	39.3	40.7	42.0		
IMR 4064		38.4	39.6	40.7	41.9	42.9		
RE 15		39.0	40.4	41.7	42.8	43.7	44.6	
N140		39.0	40.4	41.6	42.8	43.9		
Varget		37.6	38.9	40.2	41.5	42.7	44.0	
CFE 223		41.4	43.0	44.3	45.4	46.2	46.7	
Big Game		40.6	42.1	43.6	45.1	46.5	47.9	
Win 760		43.2	44.3	45.4	46.5	47.6		
H4350		43.5	44.8	46.1	47.3			
RE 17		42.1	43.3	44.5	45.6	46.7	47.8	
Energy Ft. Lbs		1451	1540	1632	1726	1824	1923	
Special Load	Powder	Grains	Velocity fps	Energy Ft. lbs				
Accuracy Load	IMR 8208 XBR	42.4	3800	1923				
Hunting Load	CFE 223	46.7	3800	1923				

6mm CREEDMOOR

	Bullet	Caliber	Weight	Type	C.O.A.L.		
	#1505	.243"	70gr.	HPBT Match	2.525"		
	#1507	.243"	70gr.	BlitzKing	2.600"		
	#1510	.243"	75gr.	HP	2.500"		
Powder	Velocity	3000	3100	3200	3300	3400	3500
IMR 3031		33.1	34.3	35.6	36.9	38.2	
IMR 8208 XBR		33.8	35.3	36.8	38.3	39.7	
H4895			34.5	36.2	37.7	39.3	40.7
IMR 4895		34.5	35.7	37.0	38.3	39.6	
IMR 4166 End.		34.4	35.7	37.1	38.5	39.9	
IMR 4064		35.0	36.4	37.8	39.3	40.8	
RE 15		35.6	37.2	38.7	40.1	41.4	42.7
N140		35.7	37.3	38.9	40.5		
Varget		34.3	35.8	37.3	38.7	40.2	41.7
CFE 223			38.0	40.1	42.3	44.5	
Big Game		38.3	39.6	40.9	42.3	43.8	45.3
Win 760		40.3	41.6	42.9	44.2	45.4	46.6
IMR 4451 End.		40.3	41.6	43.0	44.4	45.8	47.3
H4350			41.1	42.5	44.0	45.4	46.9
RE 16		39.1	40.8	42.4	43.9	45.3	
RE 17			40.3	42.1	43.6	44.9	46.0
Hunter		40.5	41.9	43.4	45.1	46.8	
Energy Ft. Lbs		1399	1493	1591	1692	1796	1904
Special Load	Powder	Grains	Velocity fps	Energy Ft. lbs			
Accuracy Load	Hunter	46.8	3400	1796			
Hunting Load	H4895	40.7	3500	1904			
<i>Sierra does not recommend MatchKing bullets for hunting applications.</i>							





6mm CREEDMOOR

	Bullet	Caliber	Weight	Type	C.O.A.L.
	#1515	.243"	80gr.	Blitz SBT	2.550"
	#1520	.243"	85gr.	SPT	2.550"
	#1530	.243"	85gr.	HPBT	2.500"



Powder	Velocity	2800	2900	3000	3100	3200	3300	3400
IMR 3031		31.8	32.9	34.0	35.1	36.1		
IMR 8208 XBR		31.7	32.9	34.1	35.5	37.0	38.6	
H4895		32.3	33.8	35.2	36.6	38.0	39.2	
IMR 4895		33.1	34.2	35.4	36.5	37.6		
IMR 4166 End.		32.4	33.6	34.9	36.2	37.6	39.0	
IMR 4064		32.9	34.2	35.5	36.9	38.4		
RE 15			34.9	36.3	37.7	39.1	40.5	
Varget		33.2	34.4	35.7	37.2	38.7	40.4	
Big Game			37.5	38.8	40.0	41.4	42.8	
Win 760		38.2	39.4	40.5	41.6	42.8	43.9	45.1
IMR 4451 End.		39.8	40.6	41.5	42.5	43.6	44.8	
H4350			38.3	40.1	41.7	43.2	44.6	
RE 16		37.5	39.0	40.5	41.9	43.2	44.4	
RE 19		41.8	42.8	43.9	45.1	46.4		
Hunter				41.0	42.5	44.1	45.7	47.4
H4831sc		41.1	42.6	44.0	45.3	46.5		
Energy Ft. Lbs		1392	1494	1598	1707	1819	1934	2053

Special Load	Powder	Grains	Velocity fps	Energy Ft. lbs
Accuracy Load	IMR 8208 XBR	38.6	3300	1934
Hunting Load	Hunter	47.4	3400	2053

6mm CREEDMOOR

	Bullet	Caliber	Weight	Type	C.O.A.L.			
	#1535	.243"	90gr.	FMJBT	2.600"			
	#4100	.243"	90gr.	TGK	2.770"*			
	#1537	.243"	95gr.	HPBT Match	2.750"*			
	#7295	.243"	95gr.	TMK Match	2.770"*			
*requires a 1x9" or faster twist								
Powder v	Velocity >	2600	2700	2800	2900	3000	3100	3200
IMR 8208 XBR		29.7	31.3	32.8	34.2	35.6	36.9	
H4895		29.9	31.3	32.7	34.1	35.6	37.1	
IMR 4166 End.		30.2	31.7	33.1	34.6	35.9	37.2	
IMR 4064		31.6	33.0	34.3	35.6	36.9	38.2	
RE 15			33.1	34.3	35.6	37.0	38.3	39.7
Varget			32.0	33.3	34.7	36.2	37.8	
Big Game			35.1	36.3	37.6	39.1	40.7	42.4
N540			32.7	34.0	35.4	36.8	38.4	40.0
IMR 4451 End.			36.7	38.1	39.4	40.8	42.2	43.7
H4350			36.2	37.6	38.9	40.3	41.7	43.1
RE 16				37.8	39.2	40.7	42.1	43.6
RE 17					38.2	39.6	41.0	42.4
RE 19	39.0	40.3	41.5	42.7	43.9	45.1	46.3	
Hunter					39.9	41.4	43.0	44.5
H4831sc				40.3	41.8	43.3	44.8	46.3
Energy Ft. Lbs		1351	1457	1566	1680	1798	1920	2046
Special Load	Powder	Grains	Velocity fps	Energy Ft. lbs				
Accuracy Load	RE 16	43.6	3200	2046				
Hunting Load	Hunter	44.5	3200	2046				

6mm CREEDMOOR

	Bullet	Caliber	Weight	Type	C.O.A.L.			
	#1540	.243"	100gr.	SPT	2.700"			
	#1560	.243"	100gr.	SBT	2.700"			
Powder	Velocity	2500	2600	2700	2800	2900	3000	3100
IMR 8208 XBR		28.3	29.7	31.2	32.7	34.3		
H4895		28.2	29.8	31.4	33.0	34.6		
IMR 4166 End.		28.9	30.3	31.8	33.3	34.8		
IMR 4064		30.1	31.5	32.9	34.4	35.8		
RE 15			31.3	32.7	34.2	35.8	37.5	
Varget			29.7	31.5	33.3	34.9		
Big Game		32.5	34.1	35.6	37.2	38.7	40.2	
N540			31.0	32.8	34.5	36.2	37.7	
IMR 4451 End.			34.9	36.6	38.2	39.8	41.2	
H4350				35.3	37.0	38.8	40.5	
RE 16				35.2	37.0	38.8	40.6	42.3
RE 17			33.6	34.9	36.4	37.8	39.3	40.9
Hybrid 100V				34.9	36.3	37.9	39.6	
RE 19				39.2	40.9	42.5	44.1	45.5
Hunter				37.4	38.9	40.4	42.1	43.7
H4831sc				38.7	40.2	42.0	43.8	
Energy Ft. Lbs		1388	1501	1618	1741	1867	1998	2133
Special Load	Powder	Grains	Velocity fps	Energy Ft. lbs				
Accuracy Load	RE 16	42.3	3100	2133				
Hunting Load	RE 16	42.3	3100	2133				

6mm CREEDMOOR

		Bullet Caliber Weight Type							C.O.A.L.
		#1570 .243" 107gr. HPBT Match							2.800"*
*requires a 1x8" or faster twist									
Powder v	Velocity >	2500	2600	2700	2800	2900	3000	3100	
IMR 4166 End.		28.9	30.3	31.8	33.3	34.8			
IMR 4064		30.1	31.5	32.9	34.4	35.8			
RE 15			31.3	32.7	34.2	35.8	37.5		
Target			29.7	31.5	33.3	34.9			
Big Game		32.5	34.1	35.6	37.2	38.7	40.2		
N540		31.1	32.6	34.1	35.6	37.1			
IMR 4451 End.			34.9	36.6	38.2	39.8	41.2		
H4350				35.3	37.0	38.8	40.5		
RE 16			35.2	37.0	38.6	40.1	41.5		
RE 17			33.6	34.9	36.4	37.8	39.3	40.9	
Hybrid 100V				34.8	36.3	37.9	39.6		
RE 19				39.2	40.9	42.5	44.1	45.5	
Hunter				37.4	38.9	40.4	42.1	43.7	
H4831sc		37.5	38.6	39.8	41.1	42.6	44.2		
Superformance			38.2	40.1	41.8	43.2	44.6	45.7	
Energy Ft. Lbs		1485	1606	1732	1862	1998	2138	2283	
Special Load	Powder	Grains	Velocity fps	Energy Ft. lbs					
Accuracy Load	H4831sc	44.2	3000	2138					
<i>Sierra does not recommend MatchKing bullets for hunting applications.</i>									

6mm CREEDMOOR

Bullet Caliber Weight Type
C.O.A.L.

#1575 .243" 110gr. HPBT Match

2.875"*

*requires a 1x7" or faster twist

Powder ∨	Velocity >	2500	2600	2700	2800	2900	3000	3100
IMR 4166 End.		29.4	30.8	32.3	33.8	35.4		
IMR 4064		31.3	32.6	33.9	35.1			
RE 15		30.2	31.6	33.1	34.6	36.1		
Varget		30.9	32.2	33.5	34.8	36.1		
Big Game		32.9	34.2	35.5	37.0	38.5		
N540		30.3	31.5	32.9	34.4	36.2		
IMR 4451 End.		34.1	35.5	37.0	38.4	39.8		
H4350		33.6	34.9	36.3	37.7	39.2	40.8	
RE 16			34.4	36.1	37.7	39.3	40.7	
RE 17		33.2	34.4	35.7	36.9	38.3	39.6	
Hybrid 100V		32.2	33.7	35.2	36.8	38.5		
RE 19		37.8	39.3	40.7	42.0	43.3	44.5	
Hunter			35.9	37.3	38.8	40.3	41.8	
H4831sc		36.5	37.8	39.2	40.8	42.4	44.1	
Superformance			38.2	40.1	41.7	43.1	44.3	45.2
Energy Ft. Lbs		1526	1651	1780	1915	2054	2198	2347

Special Load	Powder	Grains	Velocity fps	Energy Ft. lbs
--------------	--------	--------	--------------	----------------

Accuracy Load	Big Game	38.5	2900	2054
----------------------	----------	------	------	------

Sierra does not recommend MatchKing bullets for hunting applications.