

243 WINCHESTER

Test Specifications:

Firearm Used: Universal

Barrel Length: 24"

Twist: 1- 8"

Components:

Case: Winchester

Trim-to Length: 2.035"

Primer: WLR

Remarks:

Introduced in 1955, the 243 was intended to serve as a true dual purpose varmint/deer cartridge. Based on the 308 Winchester case, the 243 was the logical result of work done by noted gun writer and benchrest shooter Warren Page. Some years earlier, Page had acquired some samples of the then experimental 7.62mm NATO case, and he necked them down to accept .243" projectiles. Known as the 240 Page Pooper (Warren was rather unique in naming his wildcats), the cartridge proved to be an excellent performer.

The 243 is a tremendously versatile cartridge. With hunting bullets ranging in weight from 60 to 100 grains, the 243 is well suited to game from varmints to mule deer. Sierra offers 55 and 70 grain Blitzkings, plus 60 and 75 grain hollow point Varminters that give superb performance on prairie dogs, with the 70, 80, and 85 grain weights being excellent for chucks and coyotes, as well as other similar varmint species. The 85 HPBT GameKing, 90 grain GameChanger, as well as 100 grain Pro Hunter and GameKings being most recommended for whitetail and mule deer.

Although touted as an ideal round for recoil sensitive shooters, the cartridge's limitations must be recognized. Small caliber cartridges used for big game hunting require near perfect shot placement for quick kills, even with the heaviest bullets available. The hunter who recognizes these limitations and is willing to pass up questionable or less than perfect shots will be well served by the 243 Winchester.

The 243 has become popular as a competitive match cartridge. The Sierra offerings for long range match shooting include a 95 MatchKing, a 95 Tipped MatchKing, the 107 and 110 grain MatchKings. Special twist rates are required with some bullets. Note twist recommendations.

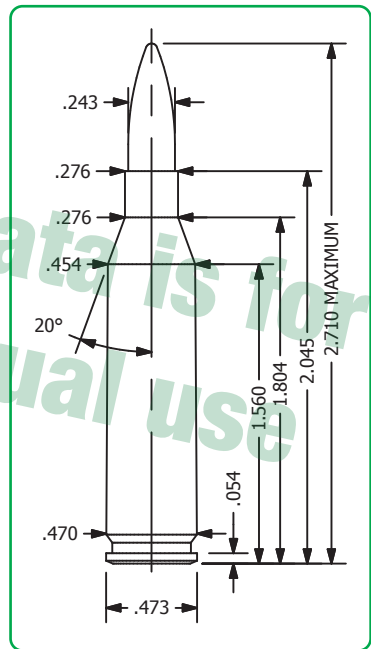



243 WINCHESTER



Bullet Caliber Weight Type							C.O.A.L.
	#1502	.243"	55gr.	BlitzKing			2.650"
Powder ∨	Velocity >	3400	3500	3600	3700	3800	3900
H322			35.7	36.7	37.9	39.3	41.0
A 2015				37.5	38.8	40.3	
Benchmark				38.2	39.5	40.8	42.0
IMR 4166 End.				40.5	42.0	43.3	
RE 15		41.5	42.0	42.7	43.4	44.2	45.2
Varget			40.2	41.4	42.6	43.8	44.9
Energy Ft. Lbs		1412	1496	1582	1672	1763	1857
Special Load	Powder	Grains	Velocity fps	Energy Ft. lbs			
Accuracy Load	A 2015	40.3	3800	1763			
Hunting Load	H322	41.0	3900	1857			

Bullet Caliber Weight Type							C.O.A.L.	
	#1500	.243"	60gr.	HP			2.560"	
Powder ∨	Velocity >	3300	3400	3500	3600	3700	3750	3800
H322				36.4	37.5			
A 2015			35.3	36.2	37.7			
IMR 3031		36.1	37.1	38.1	39.3			
Benchmark				36.9	38.3	39.7		
IMR 8208 XBR					39.1	40.6	41.4	
IMR 4895				39.2	40.7	42.2		
IMR 4166 End.			38.4	39.8	41.1	42.3		
IMR 4064				39.8	41.2			
RE 15			39.1	40.0	41.2	42.6	43.4	44.2
Varget				39.4	41.0	42.8	43.7	
Energy Ft. Lbs		1451	1540	1632	1726	1824	1873	1923
Special Load	Powder	Grains	Velocity fps	Energy Ft. lbs				
Accuracy Load	A 2015	37.7	3600	1726				
Hunting Load	RE 15	44.2	3800	1923				





243 WINCHESTER

Bullet	Caliber	Weight	Type	C.O.A.L.							
	#1505	.243"	70gr.	HPBT Match	2.580"						
	#1507	.243"	70gr.	BlitzKing	2.640"						
	#1510	.243"	75gr.	HP	2.560"						
Powder	Velocity	3000	3100	3200	3250	3300	3350	3400			
IMR 3031			34.8	36.0	36.7						
IMR 4895		35.1	36.4	37.5	38.1	38.7					
IMR 4166 End.		35.4	36.6	37.8	38.4	39.0	39.7				
RE 15				38.7	39.3	40.0	40.6	41.4			
Varget			36.0	37.2	37.9	38.6	39.5				
Power Pro 2000 MR			40.3	41.5	42.1	42.7	43.4	44.0			
IMR 4350			40.6	42.0	42.9	44.0					
IMR 4451 End.			42.2	43.5	44.3	45.0	45.8				
H4350			41.1	42.5	43.2	43.9	44.7	45.5			
RE 16				41.8	42.7	43.5	44.3	45.0			
RE 19			45.0	46.3	47.0	47.7	48.3	48.9			
H4831sc				46.0	46.7	47.5	48.4				
Energy Ft. Lbs		1399	1493	1591	1641	1692	1744	1796			
Special Load	Powder	Grains	Velocity fps	Energy Ft. lbs							
Accuracy Load	RE 19	48.9	3400	1796							
Hunting Load	RE 15	41.4	3400	1796							
<i>Sierra does not recommend MatchKing bullets for hunting applications.</i>											

243 WINCHESTER

Bullet	Caliber	Weight	Type	C.O.A.L.							
	#1515	.243"	80gr.	Blitz SBT	2.630"						
	#1520	.243"	85gr.	SPT	2.640"						
	#1530	.243"	85gr.	HPBT	2.590"						
Powder	Velocity	2650	2750	2850	2950	3050	3150	3200			
IMR 4895		30.7	32.2	33.7	35.2	36.6					
IMR 4166 End.			32.2	33.7	35.2	36.7	38.2				
RE 15				33.8	35.2	36.7	38.3	39.1			
Varget			31.8	33.3	34.8	36.3					
Power Pro 2000 MR				35.6	37.0	38.6	40.2	41.1			
IMR 4350				38.3	39.9	41.4	42.9	43.6			
IMR 4451 End.				38.3	39.9	41.5	43.0				
H4350					37.9	39.6	41.4	42.3			
RE 16					37.8	39.4	41.0	41.9			
H4831sc				40.2	42.3	44.3	46.0	46.9			
Energy Ft. Lbs		1247	1343	1443	1546	1652	1762	1819			
Special Load	Powder	Grains	Velocity fps	Energy Ft. lbs							
Accuracy Load	RE 16	41.9	3200	1819							
Hunting Load	RE 15	39.1	3200	1819							
<i>Sierra does not recommend MatchKing bullets for hunting applications.</i>											

243 WINCHESTER



	Bullet	Caliber	Weight	Type	C.O.A.L.
	#1535	.243"	90gr.	FMJBT	2.650"
	#4100	.243"	90gr.	TGK	2.700"*
	#1537	.243"	95gr.	HPBT Match	2.700"*
	#7295	.243"	95gr.	TMK Match	2.700"*
*requires a 1x9" or faster twist					

Powder	Velocity	2750	2850	2950	3050	3100	3150	3200
H4895			33.3	34.9				
IMR 4895	33.2	34.5	35.8					
RE 15	33.3	34.4	35.8	37.5				
Varget				36.1	37.4			
Power Pro 2000 MR	38.1			38.5	39.9	40.9		
IMR 4350	37.6	38.9	40.3					
IMR 4451 End.	38.3	39.6	40.9	42.4				
A 4350			39.1	40.7	42.3	43.1		
H4350			38.3	39.8	41.2	42.0		
RE 16			38.1	39.4	40.8	41.5	42.2	
RE 19	41.1	42.3	43.5	44.8	45.4	46.1	46.7	
H4831sc			42.0	43.5	45.0	45.6		
H1000			43.8	45.4	47.6			
Energy Ft. Lbs	1511	1623	1739	1859	1920	1983	2046	

Special Load	Powder	Grains	Velocity fps	Energy Ft. lbs
Accuracy Load	Varget	37.4	3050	1859
Hunting Load	RE 19	46.7	3200	2046

Sierra does not recommend MatchKing bullets for hunting applications.

243 WINCHESTER

	Bullet	Caliber	Weight	Type	C.O.A.L.
	#1540	.243"	100gr.	SPT	2.650"
	#1560	.243"	100gr.	SBT	2.650"

Powder ∨	Velocity >	2550	2650	2750	2850	2900	2950
RE 15		30.1	31.4	33.0			
Win 760			35.7	37.4	39.3		
IMR 4350			35.2	36.9			
IMR 4451 End.				37.5	39.2		
A 4350				32.9	35.5		
H4350				35.6	37.7	38.7	
RE 16				35.4	37.2	38.1	
Hybrid 100V			34.6	36.1	37.8	38.7	
RE 19				38.4	39.8	40.7	41.8
IMR 4831			37.1	38.8			
H4831sc			36.6	39.1	41.3	42.3	43.2
RE 22			37.2	38.8	40.4	41.3	42.2
Energy Ft. Lbs		1444	1559	1679	1803	1867	1932

Special Load	Powder	Grains	Velocity fps	Energy Ft. lbs
Accuracy Load	H4831sc	43.2	2950	1932
Hunting Load	RE 19	41.8	2950	1932



My son's first doe using a Rossi Single Shot 243 shooting a 100 gr SBT.
Photo: David Roberts

243 WINCHESTER

Bullet		Caliber	Weight	Type	C.O.A.L.					
		#1570	.243"	107gr.	HPBT Match	2.850"*				
*requires a 1x8" or faster twist										
Powder	Velocity	2500	2600	2700	2750	2800	2850	2900		
RE 15			31.3	32.8	33.6	34.3				
Varget			30.9	32.5	33.2	34.0				
IMR 4350			35.1	36.7	37.2	37.6				
IMR 4451 End.	34.1		35.4	36.8	37.5	38.3	39.1			
A 4350			33.8	35.4	36.3	37.2				
H4350			33.9	35.4	36.2	37.0	37.8	38.6		
RE 16			33.3	35.0	35.8	36.7	37.5	38.3		
RE 19				38.4	39.1	40.0	40.8	41.8		
IMR 4831	35.6		37.0	38.6	39.5	40.4				
H4831sc			37.2	38.8	39.5	40.3	41.2	42.0		
RE 22				38.7	39.5	40.3	41.1	41.9		
H1000			40.1	41.6	42.3	43.0	43.8	44.5		
Energy Ft. Lbs		1485	1606	1732	1796	1862	1929	1998		
Special Load	Powder	Grains	Velocity	fps	Energy	Ft. lbs				
Accuracy Load	RE 16	38.3	2900		1998					
<i>Sierra does not recommend MatchKing bullets for hunting applications.</i>										

243 WINCHESTER

Bullet	Caliber	Weight	Type	C.O.A.L.				
	#1575	.243"	110gr. HPBT Match	2.900"*				
*requires a 1x7" or faster twist								
Powder	Velocity	2450	2550	2650	2750	2800	2850	2900
RE 15			30.8	32.3	33.8	34.5		
Varget			30.1	31.8	33.4			
IMR 4350			34.4	35.8	37.3	38.0		
IMR 4451 End.			35.1	36.7	38.1	38.7	39.3	
A 4350			34.1	36.1	38.1	39.1	40.0	
H4350			33.7	35.3	36.9	37.7	38.6	
RE 16				34.2	35.8	36.7	37.5	38.3
RE 19					38.6	40.3	41.1	41.9
IMR 4831		35.1	36.6	38.2	39.8	40.7		
H4831sc			37.0	38.3	39.9	40.7	41.7	42.7
RE 22				38.3	39.7	40.5	41.2	42.0
H1000				41.1	42.6	43.4	44.2	45.0
Energy Ft. Lbs		1466	1588	1715	1847	1915	1984	2054
Special Load	Powder	Grains	Velocity fps	Energy Ft. lbs				
Accuracy Load	RE 16	38.3	2900	2054				
<i>Sierra does not recommend MatchKing bullets for hunting applications.</i>								