

# 224 VALKYRIE

## Test Specifications:

Firearm Used: Universal

Barrel Length: 24"

Twist: 1-7"

## Components:

Case: Starline\*/ Federal\*\*

Trim-to Length: 1.590"

Primer: WSR\*/Federal GM205\*\*

\*Starline/WSR (52-69gr)

\*\*Federal/GM205 (77-95gr)

## Remarks:

The quest to "upcharge" the AR-15 platform has seemingly been around for as long as the gun itself and its .223 Rem. chambering. Why is this? Well, while the .223 does exactly what it was designed to do — namely push a smallish, relatively light bullet quickly — there's always someone who wants more. More power. More range. Well, you can step up to a 7.62mm AR style for this, but that is a whole new platform. How about something that can fit on the commonly available small frame AR, yet still up the ante regarding performance?

Enter the 224 Valkyrie, the brainchild of Federal Premium. To get you to understand what the ballpark of its capabilities is, the round was designed to push a 75 grain bullet at 3,000 feet per second. It's based on the 6.8mm SPC case, which was designed to fit within a small frame AR while delivering increased power. What the 224 Valkyrie brings to the table is the voluminous power capability of this case size, necked to a bullet diameter with a wide range of projectiles available. The result is a fast, flat shooting, long range cartridge that packs into your handy AR.

While other attempts to develop a new AR friendly round have faltered, the 224 Valkyrie has taken off with shooters impressed by its performance. With bullet weights generally ranging from 60 to 90 grain weights available, the 224 has a great deal of adaptability to a wide array of shooting disciplines and needs. Many manufacturers offer rifles from the factory chambered for the round, further lending the round credence and viability.

If you're looking to expand the capabilities of the ever popular AR-15 (or even a bolt gun), then look no further than the exciting 224 Valkyrie round!

### Michael O. Humphries

Executive Editor *American Handgunner Magazine*



[www.americanhandgunner.com](http://www.americanhandgunner.com)

919 830 2506

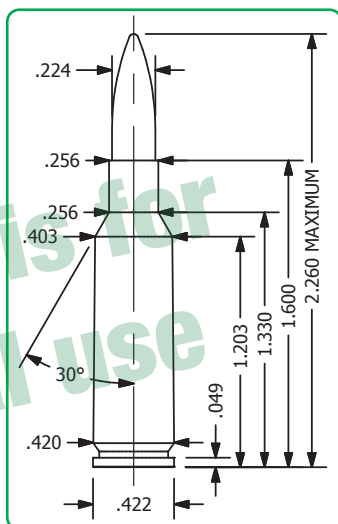
[michael.humphries@fmghq.com](mailto:michael.humphries@fmghq.com)



# 224 VALKYRIE

	Bullet	Caliber	Weight	Type	C.O.A.L.
	#1410	.224"	52gr.	HPBT Match	2.110"
	#1400	.224"	53gr.	HP Match	2.110"
	#1345	.224"	55gr.	Blitz	2.150"
	#1350	.224"	55gr.	SMP	2.110"
	#1355	.224"	55gr.	FMJBT	2.060"
	#1360	.224"	55gr.	SPT	2.170"
	#1365	.224"	55gr.	SBT	2.150"
	#1390	.224"	55gr.	HPBT	2.090"
	#1455	.224"	55gr.	BlitzKing	2.180"*



\*55gr BlitzKing requires a 1x12" or faster twist

Powder ▾	Velocity >	2700	2800	2900	3000	3100	3200	3300
RE 10x		19.9	20.7	21.5	22.3	23.0		
Benchmark		22.2	23.0	23.8	24.6	25.4		
H335			22.0	22.9	23.9	24.8	25.8	
IMR 8208 XBR				23.3	24.3	25.1	25.8	
TAC			22.5	23.5	24.4	25.3	26.1	
H4895			22.2	23.0	23.8	24.6	25.4	26.3
A 2495			22.9	23.8	24.6	25.5	26.3	
IMR 4166 End.		22.2	23.2	24.1	24.9	25.7		
IMR 4064		22.9	23.7	24.5	25.2	26.0		
Power Pro Varmint			22.6	23.7	24.6	25.5	26.4	27.1
A 2520				24.7	25.5	26.3	27.2	28.1
RE 15		22.6	23.3	24.1	24.9	25.7	26.6	
Varget		23.2	24.0	24.8	25.6	26.4	27.3	
CFE 223				25.1	25.9	26.8	27.6	28.5
Power Pro 2000 MR			23.3	25.3	26.9	28.3	29.3	29.9
N540		23.0	23.9	24.7	25.5	26.3		
AR Comp		20.6	21.5	22.3	23.2	24.1	25.1	
<b>Energy Ft. Lbs</b>		<b>842</b>	<b>905</b>	<b>971</b>	<b>1039</b>	<b>1109</b>	<b>1182</b>	<b>1257</b>

Special Load	Powder	Grains	Velocity fps	Energy Ft. lbs
<b>Accuracy Load</b>	H335	25.8	3200	1182
<b>Hunting Load</b>	H4895	26.3	3300	1257

Sierra does not recommend MatchKing bullets for hunting applications.

# 224 VALKYRIE



Bullet	Caliber	Weight	Type	C.O.A.L.
	#1375	.224"	60gr. HP	2.140"
	#7160	.224"	60gr. TMK	2.230"*
	#1370	.224"	63gr. SMP	2.100"

\*60gr TMK requires a 1x10" or faster twist

Powder	Velocity	2500	2600	2700	2800	2900	3000	3100
H335			20.6	21.6	22.5	23.5		
IMR 8208 XBR	19.9	20.8	21.7	22.6	23.6	24.5		
TAC	19.8	20.8	21.8	22.8	23.8	24.8		
H4895		20.4	21.3	22.3	23.2	24.1		
A 2495	20.2	21.1	22.0	23.0	23.9	24.8		
IMR 4166 End.	20.7	21.7	22.6	23.5	24.4			
IMR 4064	21.0	22.0	22.9	23.8	24.7			
Power Pro Varmint		20.8	21.9	22.9	23.9	24.9	25.8	
A 2520		21.8	22.8	23.8	24.8	25.8	26.8	
RE 15	21.0	22.1	23.0	23.7	24.3	24.7		
Varget	21.1	22.1	23.0	24.0	25.0	26.1		
CFE 223			23.7	24.7	25.7	26.7	27.7	
Power Pro 2000 MR		23.1	24.2	25.2	26.2	27.2	28.1	
Big Game			25.6	26.7	28.0			
N540	21.9	22.7	23.6	24.4	25.3	26.2		
RE 17			25.6	26.4	27.3	28.3		
AR Comp		19.6	20.7	21.8	22.9	23.9		
<b>Energy Ft. Lbs</b>	<b>833</b>	<b>900</b>	<b>971</b>	<b>1044</b>	<b>1120</b>	<b>1199</b>	<b>1280</b>	





Special Load	Powder	Grains	Velocity fps	Energy Ft. lbs
<b>Accuracy Load</b>	IMR 4064	24.7	2900	1120
<b>Hunting Load</b>	Power Pro Varmint	25.8	3100	1280

# 224 VALKYRIE

	Bullet	Caliber	Weight	Type	C.O.A.L.			
	#1395	.224"	65gr.	SBT	2.137"*			
	#1380	.224"	69gr.	HPBT Match	2.160"*			
	#7169	.224"	69gr.	TMK Match	2.200"*			
*requires a 1x10" or faster twist								
Powder	Velocity	2500	2600	2700	2800	2900	3000	3100
H335		20.6	21.6	22.6	23.6			
IMR 8208 XBR		21.3	22.1	23.0	23.8	24.7		
TAC		20.8	21.9	23.0	24.0	25.0	26.0	
H4895		21.0	22.0	22.9	23.8	24.6	25.4	
A 2495		21.6	22.5	23.3	24.2	25.0		
IMR 4166 End.		21.1	22.0	22.9	23.8	24.7		
IMR 4064		22.1	22.8	23.6	24.2	24.8		
Power Pro Varmint			22.1	23.1	24.1	25.0	26.0	
A 2520		22.2	23.2	24.2	25.1	26.0	26.9	
RE 15		22.4	23.2	24.0	24.9	25.7	26.5	
Varget		22.4	23.2	24.1	25.0	25.8		
CFE 223		22.0	23.2	24.3	25.3	26.3	27.1	
Power Pro 2000 MR		23.5	24.5	25.5	26.4	27.3	28.1	28.9
Big Game		23.7	24.7	25.8	27.1	28.6		
N540		22.4	23.3	24.1	24.9	25.6		
RE 17		24.7	25.5	26.2	26.9	27.6	28.3	
AR Comp		19.8	21.0	22.1	23.1	24.0	24.8	
<b>Energy Ft. Lbs</b>		<b>902</b>	<b>975</b>	<b>1052</b>	<b>1131</b>	<b>1214</b>	<b>1299</b>	<b>1387</b>
Special Load	Powder	Grains		Velocity fps	Energy Ft. lbs			
<b>Accuracy Load</b>	A 2520	26.9		3000	1299			
<b>Hunting Load</b>	Power Pro 2000 MR	28.9		3100	1387			
<i>Sierra does not recommend MatchKing bullets for hunting applications.</i>								

# 7.62x39mm 7.62x39mm 7.62x39mm 7.62x39mm

## 7.62x39mm

Bullet	Caliber	Weight	Type	C.O.A.L.
	#9377	.224"	77gr. HPBT Match	2.160"*
	#9377G	.224"	77gr. HPBT Match Cannelured	2.160"*
	#7177	.224"	77gr. TMK Match	2.200"*
	#9390	.224"	80gr. HPBT Match	2.260"*

\*requires a 1x8" or faster twist

Powder ∨	Velocity >	2300	2400	2500	2600	2700	2800	2900
H335		19.6	20.4	21.4	22.4			
IMR 8208 XBR		19.7	20.6	21.5	22.4	23.4		
TAC		20.0	21.1	22.1	23.1	24.1	25.1	
H4895		19.8	20.7	21.6	22.5	23.4	24.4	
IMR 4166 End.		20.2	21.1	22.0	22.9	23.9		
IMR 4064		20.9	21.7	22.6	23.5	24.5		
A 4064		20.7	21.6	22.7	23.7	24.8	25.8	
Power Pro Varmint		19.4	20.6	21.7	22.8	23.7	24.7	
A 2520			21.8	22.9	24.0	24.9	25.9	
RE 15		20.6	21.5	22.5	23.4	24.4	25.3	
Varget		20.2	21.1	22.0	22.9	23.9	24.9	
CFE 223			21.8	22.9	24.0	25.1	26.0	
Power Pro 2000 MR			22.7	23.7	24.6	25.6	26.5	27.5
Big Game			23.7	24.8	25.9	27.0	28.2	
N540		20.6	21.6	22.5	23.4	24.4		
RE 17		23.3	24.1	25.0	25.8	26.7	27.6	28.5
AR Comp		18.1	19.2	20.3	21.4	22.5		
<b>Energy Ft. Lbs</b>		<b>904</b>	<b>985</b>	<b>1068</b>	<b>1156</b>	<b>1246</b>	<b>1340</b>	<b>1438</b>

Special Load	Powder	Grains	Velocity fps	Energy Ft. lbs
Accuracy Load	Varget	24.9	2800	1340

*Sierra does not recommend MatchKing bullets for hunting applications.*

# 224 VALKYRIE

Bullet		Caliber	Weight	Type	C.O.A.L.					
		#9290	.224"	90gr.	HPBT Match	2.260"*				
		*requires a 1x6.5" or faster twist		**requires a 1x7" twist @2650fps and faster						
Powder	Velocity	2050	2150	2250	2350	2450	2550	2600		
H335			19.1	20.1	21.2	22.4				
TAC				20.4	21.4	22.5				
H4895				19.8	20.8	21.9				
IMR 4166 End.				20.4	21.3	22.3	23.4			
IMR 4064	19.1	20.1	21.1	22.0	23.0					
A 4064		19.6	20.6	21.7	22.8	24.1				
Power Pro Varmint					21.0	22.1	23.2			
A 2520				20.9	21.9	23.0	24.2			
RE 15				20.6	21.7	22.7	23.8	24.4		
Varget				20.4	21.4	22.4	23.4			
CFE 223				20.9	22.1	23.4	24.6			
H380				22.6	23.6	24.7	25.9	26.5		
Power Pro 2000 MR				21.7	22.8	23.9	25.0	25.6		
Big Game				22.8	23.8	24.9	26.0	26.6		
Win 760				23.1	24.6	25.9	27.1	27.6		
RE 17				22.8	23.7	24.7	25.6	26.1		
AR Comp			17.5	18.5	19.6					
<b>Energy Ft. Lbs</b>		<b>840</b>	<b>924</b>	<b>1012</b>	<b>1103</b>	<b>1199</b>	<b>1299</b>	<b>1351</b>		
Special Load	Powder	Grains	Velocity fps	Energy Ft. lbs						
<b>Accuracy Load</b>	AR Comp	19.6	2350	1103						
<i>Sierra does not recommend MatchKing bullets for hunting applications.</i>										

# 224 VALKYRIE

Bullet		Caliber	Weight	Type	C.O.A.L.				
	#1396	.224"	95gr.	HPBT Match	2.260"*				
*requires a 1x6.5" or faster twist									
Powder	Velocity	2050	2150	2250	2350	2450	2550	2600	
H335		19.1	20.3	21.3	22.3				
TAC			19.5	20.7	21.9	23.0			
H4895			19.4	20.4	21.4	22.3			
IMR 4166 End.			19.6	20.5	21.5				
IMR 4064		19.3	20.2	21.2	22.1				
A 4064		19.1	20.2	21.3	22.4	23.5			
Power Pro Varmint			19.2	20.4	21.7	22.9			
A 2520			20.2	21.4	22.6	23.6			
RE 15		19.1	20.0	21.0	22.1	23.2			
Varget			19.8	20.9	21.9				
CFE 223			20.4	21.8	23.0	24.1			
H380			22.1	23.2	24.2	25.3	26.5		
Power Pro 2000 MR			21.0	21.6	22.5	23.8	25.3		
Big Game			22.1	23.1	24.0	25.0	26.1		
Win 760			22.7	24.0	25.2	26.3	27.3		
RE 17				22.9	23.9	24.9	25.8		
<b>Energy Ft. Lbs</b>		<b>886</b>	<b>975</b>	<b>1068</b>	<b>1165</b>	<b>1266</b>	<b>1371</b>	<b>1426</b>	
Special Load	Powder	Grains	Velocity	fps	Energy	Ft. lbs			
<b>Accuracy Load</b>	A 2520	23.6	2450		1266				
<i>Sierra does not recommend MatchKing bullets for hunting applications.</i>									