

223 REMINGTON (AR-15)

Test Specifications:

Firearm Used: Colt AR 15A2 HBAR

Barrel Length: 20"

Twist: 1 x 7"

Components:

Case: Federal

Trim-to Length: 1.750"

Primer: Rem 7 1/2

Remarks:

Inadequate for military purposes, not as accurate as the 222 Remington, and less powerful than the 222 Magnum. These were just some of the greetings given to Remington's 223, when it was unveiled as the 5.56mm in the AR-15/M16 rifle. In spite of its early critics, the 223 Remington has



become one of the most popular sporting cartridges, and has proven itself in several military conflicts worldwide. Perhaps its greatest compliment as a service round came when the former Soviet Union replaced its 7.62x39mm cartridge with a 22 caliber service round that closely duplicated the 223's performance.

While adoption by the military virtually assures a cartridge's popularity, the 223 is perfectly capable of standing on its own merits. It is an outstanding varmint cartridge out to 250-275 yards, especially when loaded with 50 or 55 grain Blitz bullets. It is an extremely easy cartridge to load for, responding well to a wide variety of components. Hodgdon's H335, Winchester 748 and Reloader 7 are all top choices, generally giving good velocity and excellent accuracy. Surplus military cases add to the popularity of any cartridge, and the 223 has been no exception. If military cases are used, the primer pocket will need to be swaged or reamed to remove the crimp and allow seating of a new primer.

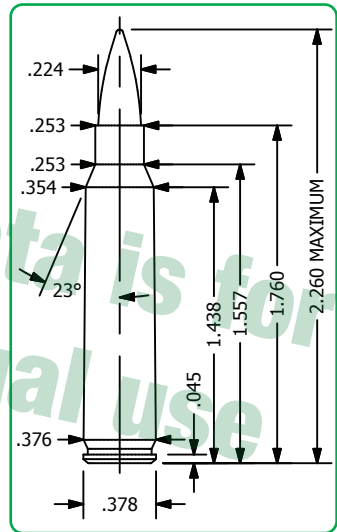
In recent years, the 223 Remington has gained acceptance as a target round, being used mostly in the "service rifle" category of the National Match Course. In 1992, Sierra announced an 80 grain MatchKing specifically for the 600-yard stage of this type of competition. As this is a slow-fire stage, the 80 grain HPBT should be seated to approximately 2.550" OAL, and must be singleloaded. This bullet requires the use of a 1x7" or 1x8" twist for proper stability.





223 REMINGTON (AR-15)

	Bullet	Caliber	Weight	Type	C.O.A.L.
	#1200	.224"	40gr.	Hornet	2.125"
	#1385	.224"	40gr.	HP	2.175"
	#1440	.224"	40gr.	BlitzKing	2.250"





Powder	Velocity	3100	3200	3300	3400	3500	3600
Viht N130			23.2	23.7	24.2	24.7	25.2
Viht N133		24.6	25.2	25.8	26.4		
IMR 4198			22.0	22.6	23.2		
A 2015		24.5	25.2	25.9	26.6		
Benchmark		24.9	25.6	26.3	27.0		
H322		24.4	25.3				
X Terminator			25.0	25.7	26.4	27.1	
A 2230			25.5	26.5	27.5		
748		27.4	28.0				
H335		26.0	26.6	27.2	27.8	28.4	
TAC			25.9	26.9	27.9		
Energy Ft. lbs		853	909	967	1027	1088	1151

Special Load	Powder	Grains	Velocity fps	Energy Ft. lbs
Accuracy Load	H322	25.3	3200	909
Hunting Load	IMR 4198	23.2	3400	1027



223 REMINGTON (AR-15)

		Bullet	Caliber	Weight	Type						C.O.A.L.
		#1210	.224"	45gr.	Hornet						2.125"
		#1310	.224"	45gr.	SPT						2.240"
Powder	Velocity	3000	3100	3200	3300	3400	3450				
Viht N130			22.8	23.4	24.0	24.6	24.9				
Viht N133		23.9	24.5	25.1	25.7						
IMR 4198		20.7	21.4	22.1	22.8						
A 2015		24.2	24.8	25.4							
RE 7		21.6	22.2	22.8							
IMR 3031		24.7	25.2								
Benchmark		24.7	25.3	25.9	26.5						
H322		24.5	25.1	25.7							
X Terminator		24.0	24.7	25.4	26.1						
A 2230		25.2	25.9	26.6	27.3						
748		27.2	27.9								
BL C(2)		28.1	28.8	29.5							
H335		25.6	26.3	27.0	27.7						
TAC		25.5	26.2	26.9	27.6	28.3					
Viht N135		24.5	25.3	26.1	26.9						
Energy Ft. lbs		899	960	1023	1088	1155	1189				
Special Load	Powder	Grains	Velocity	fps	Energy	Ft. lbs					
Accuracy Load	X Terminator	26.1	3300	1088							
Hunting Load	Viht N130	24.6	3400	1155							







7.23 REMINGTON (AR-15)

	Bullet	Caliber	Weight	Type	C.O.A.L.				
	#1320	.224"	50gr.	SMP	2.230"				
	#1330	.224"	50gr.	SPT	2.250"				
	#1340	.224"	50gr.	Blitz	2.250"				
	#1450	.224"	50gr.	BlitzKing	2.250"				
Powder	Velocity	2800	2900	3000	3100	3200	3250	3300	
Viht N130		22.1	22.6	23.1	23.6	24.1	24.3	24.6	
Viht N133			23.5	24.2	24.9	25.6	25.9		
IMR 4198		20.1	20.7	21.3	21.9	22.5			
A 2015		23.3	23.9	24.5	25.1	25.7			
RE 7		20.2	20.9	21.6	22.3	23.0			
IMR 3031		23.7	24.2	24.7	25.2				
Benchmark		23.3	24.1	24.9	25.7	26.5			
H322		23.1	23.8	24.5	25.2				
X Terminator			23.5	24.3	25.1	25.9			
A 2230			24.9	25.6	26.3	27.0			
748			26.6	27.2	27.8				
BL C(2)		26.5	27.2						
H335		24.3	25.0	25.7	26.4				
TAC			24.3	25.1	25.9	26.7	27.1	27.5	
IMR 4895		24.8	25.6	26.4					
Viht N135		23.9	24.5	25.1	25.7				
IMR 4320		26.1	26.9						
Energy Ft. lbs		870	934	999	1067	1137	1172	1209	
Special Load	Powder	Grains	Velocity fps	Energy Ft. lbs					
Accuracy Load	Viht N135	25.7	3100	1067					
Hunting Load	X Terminator	25.9	3200	1137					

223 REMINGTON (AR-15)

		Bullet Caliber Weight Type					C.O.A.L.				
	#1410	.224"	52gr.	HPBT	MatchKing	2.250"					
	#1400	.224"	53gr.	HP	MatchKing	2.250"					
Powder ▾	Velocity >	2700	2800	2900	3000	3050	3100	3150	3200		
Viht N130			21.1	21.9	22.7						
Viht N133		22.3	22.9	23.5	24.1						
IMR 4198		19.6	20.3	21.0							
A 2015		22.4	23.1	23.8	24.5	24.9	25.2				
RE 7		19.6	20.4	21.2	22.0	22.4					
IMR 3031		22.7	23.5	24.3	25.1						
Benchmark			23.6	24.3	25.0	25.4	25.7				
H322			23.1	23.8	24.5	24.9	25.2				
X Terminator			22.7	23.5	24.3	24.7	25.1				
A 2230			23.6	24.4	25.2	25.6	26.0				
748			24.8	25.7	26.6	27.1	27.5				
BL C(2)		25.8	26.6								
H335			24.3	25.0	25.7	26.1	26.4	26.7			
TAC			23.5	24.3	25.1	25.5	25.9	26.3	26.7		
IMR 4895		24.4	25.1	25.8	26.5						
Viht N135		23.6	24.1	24.6	25.1	25.4	25.6				
Varget		25.1	25.9	26.7	27.5						
IMR 4064		24.6	25.2	25.8							
IMR 4320		25.4	26.2	27.0							
Energy Ft. lbs		842	905	971	1039	1074	1109	1145	1182		
Special Load	Powder	Grains	Velocity fps	Energy Ft. lbs							
Accuracy Load	Viht N133	23.5	2900	971							
<i>Sierra does not recommend MatchKing bullets for hunting applications.</i>											

223 REMINGTON (AR-15)



	Bullet	Caliber	Weight	Type	C.O.A.L.
	#1345	.224"	55gr.	Blitz	2.250"
	#1350	.224"	55gr.	SMP	2.230"
	#1355	.224"	55gr.	FMJBT	2.250"
	#1360	.224"	55gr.	SPT	2.250"
	#1365	.224"	55gr.	SBT	2.250"
	#1390	.224"	55gr.	HPBT	2.240"
	#1455	.224"	55gr.	BlitzKing	2.250"*

*55gr BlitzKing requires a 1x12" or faster twist



Powder ▾	Velocity >	2700	2800	2900	3000	3050	3100
Viht N130			21.4	22.0	22.6	22.9	
Viht N133		22.6	23.1	23.6	24.1		
IMR 4198		19.7	20.3	20.9	21.5	21.8	
A 2015		22.4	23.1	23.8	24.5	24.9	25.2
RE 7		20.1	20.8	21.5			
IMR 3031		23.1	23.6	24.1	24.6		
Benchmark			23.6	24.4	25.2		
H322		22.5	23.1	23.7	24.3		
X Terminator			22.7	23.5	24.3	24.7	25.1
A 2230		23.3	24.0	24.7	25.4	25.8	26.1
748		25.1	25.8	26.5			
H335		23.6	24.3	25.0	25.7		
TAC				24.7	25.5	25.9	26.3
IMR 4895		24.2	24.9	25.6			
Viht N135		23.2	23.8	24.4	25.0	25.3	25.6
Varget		25.1	25.8	26.5	27.2		
IMR 4064		24.8	25.3	25.8			
IMR 4320		25.5	26.1	26.7			
Energy Ft. lbs		890	957	1027	1099	1136	1173

Special Load	Powder	Grains	Velocity fps	Energy Ft. lbs
Accuracy Load	RE 7	21.5	2900	1027
Hunting Load	H335	25.7	3000	1099



223 REMINGTON (AR-15)

	Bullet	Caliber	Weight	Type	C.O.A.L.		
	#1375	.224"	60gr.	HP	2.250"		
	#7160	.224"	60gr.	TMK	2.250"		
*60gr TMK requires a 1x10" or faster twist							
Powder	Velocity	2600	2700	2800	2900	2950	3000
Viht N130			20.6	21.3	22.0	22.3	
Viht N133			22.2	23.0			
IMR 4198			19.4	20.1	20.8	21.1	
A 2015	22.0	22.7	23.4	24.1	24.5	24.8	
RE 7	19.3	20.0	20.7	21.4			
IMR 3031	22.5	23.1					
Benchmark				23.4	24.2	24.6	25.0
H322	21.7	22.4	23.1	23.8			
X Terminator	22.2	22.8	23.4	24.0	24.3	24.6	
A 2230		22.9	23.8	24.7	25.1		
748	24.3	25.0	25.7	26.4			
H335	23.5	24.1	24.7	25.3	25.6		
TAC		23.4	24.2	25.0	25.4	25.8	
IMR 4895	23.7	24.4	25.1				
Viht N135		23.1	23.9	24.7			
Varget	24.3	25.0	25.7	26.4	26.7	27.1	
IMR 4064	23.9	24.6					
IMR 4320	24.8	25.5	26.2				
Energy Ft. lbs	900	971	1044	1120	1159	1199	
Special Load	Powder	Grains	Velocity fps	Energy Ft. lbs			
Accuracy Load	Viht N135	24.7	2900	1120			
Hunting Load	Viht N130	22.3	2950	1159			



223 REMINGTON (AR-15)

	Bullet	Caliber	Weight	Type	C.O.A.L.		
	#1370	.224"	63gr.	SMP	2.250"		
	#1395	.224"	65gr.	SBT	2.260"*		
*requires 1 x 10" twist or faster twist							
Powder	Velocity	> 2600	2700	2800	2850	2900	2950
Viht N130	19.3	20.4	21.5	22.0			
Viht N133	21.4	22.2	23.0				
A 2015	22.0	22.8	23.6	24.0	24.4		
RE 7	19.3	20.2	21.1	21.5			
Benchmark	22.8	23.4	24.0	24.3	24.6		
H322	21.9	22.6	23.3				
X Terminator	21.3	22.3	23.3	23.8	24.3		
A 2230		23.5	24.2	24.5	24.9		
748	24.3	25.1	25.9				
H335	22.8	23.6	24.4	24.8	25.2	25.6	
TAC		23.0	24.0	24.5	25.0	25.5	
IMR 4895	23.5	24.3					
Viht N135	22.1	23.0	23.9	24.3			
IMR 4064	23.9	24.7					
IMR 4320	24.9	25.7					
Energy Ft. lbs	945	1020	1097	1136	1176	1217	
Special Load	Powder	Grains	Velocity fps	Energy Ft. lbs			
Accuracy Load	H335	25.2	2900	1176			
Hunting Load	TAC	25.5	2950	1217			

223 REMINGTON (AR-15)

	Bullet	Caliber	Weight	Type	C.O.A.L.			
	#1380	.224"	69gr.	HPBT MatchKing	2.260"*			
	#7169	.224"	69gr.	TMK Match	2.260"*			
*requires a 1x10" or faster twist								
Powder	Velocity	2500	2600	2700	2750	2800	2850	2900
Viht N133		21.1	21.8	22.5				
IMR 4198		18.8	19.4	20.0	20.3			
X Terminator			21.9	22.6	22.9	23.3		
A 2230		21.9	22.7	23.5				
748		23.7	24.4	25.1	25.5	25.8		
A 2460			22.9	23.7	24.1	24.5		
H335		21.2	22.5	23.8				
TAC		22.1	22.8	23.5	23.8	24.2		
IMR 4895		22.9	23.7	24.5				
Viht N135		21.7	22.5					
Varget		23.3	24.1	24.9	25.3	25.7	26.1	
IMR 4064		23.3	24.1					
A 2520			23.1	23.8	24.3	24.7	25.1	25.5
IMR 4320		24.0	24.7	25.4				
Viht N140		23.1	23.9	24.7	25.1			
RE 15		23.3	24.1	24.9	25.3	25.7		
Energy Ft. lbs		957	1036	1117	1158	1201	1244	1288
Special Load	Powder	Grains	Velocity	fps	Energy	Ft. lbs		
Accuracy Load	Varget	25.3	2750		1158			
<i>Sierra does not recommend MatchKing bullets for hunting applications.</i>								

7.62x39mm REMINGTON (AR-15)

	Bullet	Caliber	Weight	Type	C.O.A.L.			
	#9377	.224"	77gr.	HPBT MatchKing	2.260"*			
	#9377G	.224"	77gr.	HPBT Match Cannelured	2.260"*			
	#7177	.224"	77gr.	TMK Match	2.260"*			
*requires a 1x8" or faster twist								
Powder	Velocity	2400	2500	2550	2600	2650	2700	2750
H322		20.6	21.4	21.8				
A 2230		20.9	21.9	22.4	22.9	23.4		
748		22.7	23.4					
H335		21.6	22.3	22.6				
TAC			21.8	22.2	22.7	23.1	23.6	24.0
H4895		22.2	22.9	23.2	23.6			
A 2495		22.1	23.1	23.6	24.1			
Varget		22.6	23.5	23.9				
A 2520		21.5	22.4	22.8	23.3	23.8	24.2	
Viht N140		22.3	23.2	23.6	24.1	24.5		
Viht N540		22.9	23.7	24.1	24.5	24.9		
RE 15		22.3	23.2	23.6	24.1			
Energy Ft. lbs		985	1068	1112	1156	1200	1246	1293
Special Load	Powder	Grains	Velocity fps	Energy Ft. lbs				
Accuracy Load	Viht N140	24.1	2600	1156				
<i>Sierra does not recommend MatchKing bullets for hunting applications.</i>								

223 REMINGTON (AR-15)

Bullet		Caliber	Weight	Type	C.O.A.L.				
	#9390	.224"	80gr.	HPBT MatchKing	2.550"				
*requires a 1x8" or faster twist									
Powder	Velocity	2300	2400	2500	2550	2600	2650	2700	
A 2015		19.6	20.7						
748		21.3	22.4	23.5					
A 2460		20.0	21.1	22.2	22.7				
H335		20.5	21.5	22.5					
TAC			21.4	22.2	22.6	23.0			
H4895		20.7	21.6	22.5	22.9				
A 2495		20.8	21.8	22.8					
Varget		21.3	22.2	23.1	23.6	24.0			
IMR 4064		21.4	22.2	23.0	23.4	23.8			
A 2520		21.2	21.9	22.6	22.9	23.3	23.6	24.0	
Viht N140		21.0	22.0	23.0	23.5				
Viht N540		21.8	22.6	23.4	23.8	24.2			
RE 15		20.8	21.8	22.8	23.3	23.8			
Energy Ft. lbs		940	1023	1110	1155	1201	1247	1295	
Special Load	Powder	Grains	Velocity fps	Energy Ft. lbs					
Accuracy Load	Viht N140	23.5	2550	1155					
<i>Sierra does not recommend MatchKing bullets for hunting applications.</i>									