

222 Remington Magnum

Test Specifications:

Firearm Used: Universal

Barrel Length: 24"

Twist: 1-12"

Components:

Case: Nosler

Trim-to Length: 1.840"

Primer: WSR

Remarks:



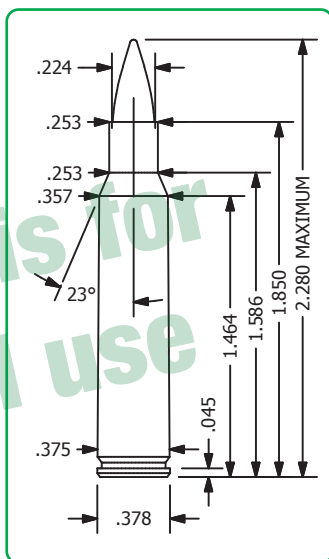

By the late 1950s, development of a small caliber high velocity military cartridge was well under way. In 1957, Earle Harvey of Springfield Armory designed a lengthened version of the already popular 222 Remington. Designated as the 224 Springfield, Remington produced approximately 10,000 rounds of unheadstamped ammunition for trials. Of this initial run, 9,500 were loaded with Sierra 55 grain FMJ bullets, while the remaining 500 were loaded with Sierra 68 grain FMJBT bullets. Interestingly enough, this was some 25 years before we introduced the 69 grain MatchKing HPBT. While the cartridge met the military requirements in terms of accuracy and trajectory, the rifle fielded by Springfield did not live up to expectations, and was dropped from further trials. Remington was quick to see the potential of the 224 Springfield, and immediately adopted it as their own. Renamed the 222 Remington Magnum, the new cartridge was introduced to the civilian market in 1958.

While the 222 Magnum is a first rate cartridge, it never did attain the popularity of the standard 222 Remington. Military adoption of the 223 Remington (5.56mm) proved to be the last blow for both the 222 and the 222 Magnum, and the 223 has now virtually replaced both of them.





For those shooters still using the 222 Magnum, excellent results can be obtained with a wide variety of components. Sierra's Blitz and BlitzKing bullets are particularly well suited to varmint shooting at the 222 Magnum's velocities. With fast twist barrels and the Sierra Tipped MatchKings (TMK) and other heavy for caliber MatchKings, this cartridge can do very well in the long distance games that are so popular. Easy to load for and capable of outstanding accuracy, the 222 Remington Magnum will continue to see use in the field for many years to come.



22Z REMINGTON MAGNUM

	Bullet	Caliber	Weight	Type					C.O.A.L.
	#1200	.224"	40gr.	Hornet					2.170"
	#1385	.224"	40gr.	HP					2.225"
	#1440	.224"	40gr.	BlitzKing					2.280"
Powder	Velocity	3200	3300	3400	3500	3600	3700	3800	
LT 32			23.4	24.1	24.7	25.3	25.9		
RE 10x		22.5	23.8	24.8	25.6	26.1	26.4		
Benchmark		24.3	25.0	25.8	26.6	27.4	28.3		
IMR 8208 XBR			26.1	26.7	27.4	28.1	29.0		
TAC					27.6	28.7	29.8	31.0	
Exterminator				25.7	26.6	27.4	28.1	28.8	
Power Pro Varmint				27.7	29.7				
Energy Ft. Lbs		909	967	1027	1088	1151	1216	1282	
Special Load	Powder	Grains	Velocity fps	Energy Ft. lbs					
Accuracy Load	Benchmark	28.3	3700	1216					
Hunting Load	TAC	31.0	3800	1282					
	Bullet	Caliber	Weight	Type					C.O.A.L.
	#1210	.224"	45gr.	Hornet					2.240"
	#1310	.224"	45gr.	SPT					2.240"
Powder	Velocity	3100	3200	3300	3400	3500	3550	3600	
LT 32		21.5	22.6	23.5	24.3	25.0			
RE 10x				23.0	24.0	24.9	25.3	25.6	
Benchmark				25.1	25.9	26.7	27.0	27.3	
IMR 8208 XBR				25.6	26.4	27.3	27.8		
TAC					26.0	26.8	27.3	27.9	
IMR 4166 End.			25.2	26.1	26.9				
Exterminator					25.0	26.3	26.8	27.3	
Power Pro Varmint					27.1	27.9	28.3	28.7	
Energy Ft. Lbs		960	1023	1088	1155	1224	1259	1295	
Special Load	Powder	Grains	Velocity fps	Energy Ft. lbs					
Accuracy Load	TAC	27.9	3600	1295					
Hunting Load	RE 10x	25.6	3600	1295					

7ZZ REMINGTON MAGNUM

	Bullet	Caliber	Weight	Type	C.O.A.L.
	#1320	.224"	50gr.	SMP	2.280"
	#1330	.224"	50gr.	SPT	2.280"
	#1340	.224"	50gr.	Blitz	2.280"
	#1450	.224"	50gr.	BlitzKing	2.280"

Powder ▾	Velocity >	2900	3000	3100	3200	3300	3400	3500
LT 32			21.2	22.1	22.9	23.8		
RE 10x			21.0	21.9	22.8	23.6	24.3	
Benchmark		22.8	23.4	24.1	24.9	25.6	26.4	
IMR 8208 XBR				24.3	25.1	26.0	26.9	
TAC				24.2	25.3	26.2	26.9	
H4895		23.2	24.0	24.8	25.5	26.3		
IMR 4166 End.		23.2	24.0	24.8	25.6	26.4		
Exterminator				22.9	24.0	25.1	26.2	
Power Pro Varmint				24.2	25.1	26.0	26.9	27.8
Varget		24.5	25.2	25.9	26.7	27.5		
Energy Ft. Lbs		934	999	1067	1137	1209	1283	1360

Special Load	Powder	Grains	Velocity fps	Energy Ft. lbs
Accuracy Load	LT 32	23.8	3300	1209
Hunting Load	Power Pro Varmint	27.8	3500	1360

22Z REMINGTON MAGNUM

Bullet	Caliber	Weight	Type	C.O.A.L.
	#1410	.224"	52gr. HPBT Match	2.280"
	#1400	.224"	53gr. HP Match	2.280"
	#1345	.224"	55gr. Blitz	2.280"
	#1350	.224"	55gr. SMP	2.260"
	#1355	.224"	55gr. FMJBT	2.300"
	#1360	.224"	55gr. SPT	2.280"
	#1365	.224"	55gr. SBT	2.280"
	#1390	.224"	55gr. HPBT	2.250"
	#1455	.224"	55gr. BlitzKing	2.280"*



*55gr BlitzKing requires a 1x12" or faster twist

Powder	Velocity	2750	2850	2950	3050	3150	3250	3300
LT 32			20.3	21.4	22.3	23.3		
RE 10x			19.8	21.1	22.2	23.1	23.7	
Benchmark				22.4	23.3	24.3	25.2	
IMR 8208 XBR			22.4	23.3	24.1	24.9	25.8	26.2
TAC				23.0	23.9	24.8	25.8	26.4
H4895	22.4	23.1	23.8	24.4	25.1	25.7	25.9	
IMR 4166 End.			23.3	24.1	24.8	25.5		
Exterminator					23.0	24.1	25.3	
Varget	23.7	24.6			25.4	26.3	27.2	
CFE 223					25.8	26.8	27.6	27.9
Power Pro 2000 MR				26.8	27.3	27.9	28.6	28.9
AR Comp				21.6	22.9	24.0	25.0	
Energy Ft. Lbs		873	938	1005	1074	1145	1219	1257

Special Load	Powder	Grains	Velocity fps	Energy Ft. lbs
Accuracy Load	AR Comp	25.0	3250	1219
Hunting Load	IMR 8208 XBR	26.2	3300	1257

Sierra does not recommend MatchKing bullets for hunting applications.

22Z REMINGTON MAGNUM

	Bullet	Caliber	Weight	Type	C.O.A.L.			
	#1375	.224"	60gr.	HP	2.280"			
	#7160	.224"	60gr.	TMK	2.280"*			
	#1370	.224"	63gr.	SMP	2.280"			
*60gr TMK requires a 1x10" or faster twist								
Powder	Velocity	2650	2750	2850	2950	3000	3050	3100
LT 32		19.3	20.3	21.3	22.3			
RE 10x			19.9	20.8	21.8	22.4		
Benchmark				22.1	23.0	23.6	24.2	
IMR 8208 XBR				22.9	23.9	24.4	24.9	
TAC				23.5	24.5	24.9	25.4	
H4895	21.2	22.0	22.9	23.7	24.1	24.4	24.4	24.8
IMR 4166 End.	21.8	22.7	23.6	24.4				
Exterminator				22.2	23.3	23.9	24.6	
Varget			23.1	23.9	24.8	25.2	25.6	
CFE 223					25.4	25.9	26.4	26.8
Power Pro 2000 MR				25.8	26.7	27.2	27.6	28.0
AR Comp				21.8	22.9	23.4	23.9	
Energy Ft. Lbs	935	1007	1082	1159	1199	1239	1280	
Special Load	Powder	Grains	Velocity	fps	Energy	Ft. lbs		
Accuracy Load	Benchmark	24.2	3050		1239			
Hunting Load	H4895	24.8	3100		1280			