

22 NOSLER

Test Specifications:

Firearm Used: Universal

Barrel Length: 24"

Twist: 1-10"

Components:

Case: Nosler

Trim-to Length: 1.750"

Primer: WSR

Remarks:

In 2017, we saw the continuation of the line of Nosler proprietary cartridges with the introduction of the .22 Nosler. Differing from all the others, this one was not simply another rifle cartridge to be chambered in any bolt action or single shot rifle but specifically designed for use in the AR15 platform and to outperform anything else chambered in it.

To function properly in an AR15 type rifle, case length of 1.760 inches and an overall cartridge length of 2.260 inches match those of the AR staple, the .223 Remington. Likewise, the .223 Remington rim diameter of .378 inches is maintained but the body diameter is much larger, approximating that of the 6.8 Remington SPC cartridge but with a 30 degree shoulder angle resulting in a rebated rim cartridge design. The maximum average pressure limit of the .223 is maintained at 55,000 psi as are the use of small rifle primers. Standard 6.8 Remington SPC magazines are used with the cartridge in the AR platform.

My interest in the cartridge, however, was in a bolt action and Nosler had covered that base as well. Along with a Nosler Model 48 Heritage rifle, I accumulated dies, brass, powders and bullets.

In an AR15 rifle the .22 Nosler cartridge is clearly an improvement over the .223, often to the tune of a 200 to 300 fps advantage. When we get to the bolt action, comparisons are more likely to be made to the .22 250 Remington. Here the Nosler cartridge suffers at times against the larger case capacity of the .22 250 and with the latter's maximum average pressure limit of 63,500 psi but that's not the whole story. The .22 Nosler with its 1 in 8 inch twist handles heavier bullets than a typical 1 in 14 inch twist .22 250 and is much better suited for hunting our smaller big game such as deer and antelope.



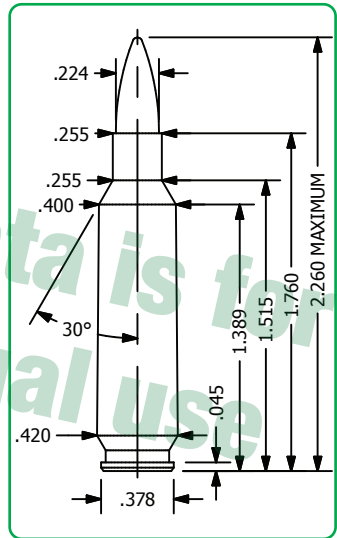

Sierra makes an impressive array of .22 caliber bullets from a 40 grain HP Varminter to a whopping 95 grain Matchking. Given the .22 Nosler's twist, I've come to prefer the 55 grain Blitzking for varmint use and the heavier 65 grain Gameking for deer sized game.

For purely target work, the 77 grain HPBT Matchking is hard to beat.





For folks wanting a .22 caliber rifle capable of handling our most commonly hunted big game while dealing with any varmints that may come their way, the .22 Nosler is worthy of consideration in either platform. By: R.H.VanDenburg,Jr





ZZ NOSLER

	Bullet	Caliber	Weight	Type	C.O.A.L.			
	#1200	.224"	40gr.	Hornet	2.100"			
	#1385	.224"	40gr.	HP	2.150"			
	#1440	.224"	40gr.	BlitzKing	2.220"			
	#1210	.224"	45gr.	Hornet	2.100"			
	#1310	.224"	45gr.	SPT	2.200"			
Powder	Velocity	3100	3200	3300	3400	3500	3600	3700
RE 10x		23.1	23.6	24.2	25.0	26.0	27.1	
Benchmark		25.8	26.6	27.4	28.2	29.0	29.9	
A 2460				27.9	28.8	29.8	30.8	
IMR 8208 XBR		26.7	27.3	27.9	28.6	29.4	30.2	31.1
TAC			27.1	28.0	29.3	30.7		
H4895		25.8	26.8	27.8				
Power Pro Varmint		26.1	26.7	27.3	28.1	29.0	30.0	31.1
N540		27.3	28.4	29.4	30.2	30.9	31.5	
Energy Ft. Lbs		853	909	967	1027	1088	1151	1216
Special Load	Powder	Grains		Velocity fps	Energy Ft. lbs			
Accuracy Load	A 2460	30.8		3600	1151			
Hunting Load	IMR 8208 XBR	31.1		3700	1216			

22 NOSLER

		Bullet	Caliber	Weight	Type	C.O.A.L.			
	#1320	.224"	50gr.	SMP	2.150"				
	#1330	.224"	50gr.	SPT	2.200"				
	#1340	.224"	50gr.	Blitz	2.200"				
	#1450	.224"	50gr.	BlitzKing	2.240"				
Powder	Velocity	3000	3100	3200	3300	3400	3500	3600	
RE 10x		22.2	23.0	23.9	25.0	26.1			
Benchmark		24.7	25.5	26.4	27.2	28.2	29.1		
A 2460		25.0	25.9	26.9	27.9	28.9	29.9		
IMR 8208 XBR		24.6	25.7	26.7	27.7	28.7	29.6		
TAC		25.7	26.5	27.4	28.4	29.3	30.3		
H4895		25.1	25.9	26.8	27.6	28.4	29.1		
IMR 4166 End.		25.7	26.6	27.6	28.5				
Power Pro Varmint		25.6	26.3	27.1	27.9	28.8	29.9	31.0	
A 2520		26.4	27.5	28.6	29.6	30.6	31.5		
Varget		26.5	27.4	28.2	29.0	29.8	30.6		
N540		26.8	27.9	28.8	29.5	30.2	30.8		
AR Comp		23.9	24.9	25.8	26.8	27.8	28.7		
Energy Ft. Lbs		999	1067	1137	1209	1283	1360	1439	
Special Load	Powder	Grains		Velocity fps		Energy Ft. lbs			
Accuracy Load	Benchmark	29.1		3500		1360			
Hunting Load	Power Pro Varmint	31.0		3600		1439			

ZZ NOSLER

	Bullet	Caliber	Weight	Type	C.O.A.L.
	#1410	.224"	52gr.	HPBT Match	2.240"
	#1400	.224"	53gr.	HP Match	2.240"
	#1345	.224"	55gr.	Blitz	2.240"
	#1350	.224"	55gr.	SMP	2.240"
	#1355	.224"	55gr.	FMJBT	2.220"
	#1360	.224"	55gr.	SPT	2.240"
	#1365	.224"	55gr.	SBT	2.240"
	#1390	.224"	55gr.	HPBT	2.240"
	#1455	.224"	55gr.	BlitzKing	2.240"*



*55gr BlitzKing requires a 1x12" or faster twist

Powder ∨	Velocity >	2800	2900	3000	3100	3200	3300	3400
H335		24.0	24.9	25.7	26.7	27.6	28.6	
H4895		23.7	24.8	25.8	26.7	27.5	28.3	29.0
IMR 4166 End.		24.3	25.4	26.4	27.3	28.1		
IMR 4064		25.3	26.1	27.0	27.8	28.6		
A 4064		25.7	26.6	27.5	28.3	29.1	29.9	
A 2520		25.2	26.4	27.5	28.5	29.5	30.3	31.1
RE 15		25.8	26.8	27.7	28.6	29.3	30.0	
Varget		24.9	25.8	26.7	27.6	28.4	29.3	30.1
Power Pro 2000 MR		27.5	28.4	29.3	30.2	31.1	32.0	32.9
Big Game		27.7	28.6	29.5	30.6	31.7	32.8	
RE 17		28.7	29.5	30.3	31.1	31.9	32.6	
AR Comp			23.7	24.8	25.8	26.8	27.6	
Energy Ft. Lbs		905	971	1039	1109	1182	1257	1335



Special Load	Powder	Grains	Velocity fps	Energy Ft. lbs
Accuracy Load	A 2520	31.1	3400	1335
Hunting Load	H4895	29.0	3400	1335

Sierra does not recommend MatchKing bullets for hunting applications.

22 NOSLER

	Bullet	Caliber	Weight	Type	C.O.A.L.			
	#1375	.224"	60gr.	HP	2.260"			
	#7160	.224"	60gr.	TMK	2.260"*			
	#1370	.224"	63gr.	SMP	2.260"			
*60gr TMK requires a 1x10" or faster twist								
Powder	Velocity	2600	2700	2800	2900	3000	3100	3200
H335		23.2	24.3	25.3	26.2	26.9		
H4895			22.0	23.2	24.3	25.4	26.4	
A 2495			23.8	24.8	25.8	26.8		
IMR 4166 End.	23.3	24.0	24.8	25.8	27.0			
A 4064			25.0	26.1	27.1			
RE 15			25.6	26.6	27.7	28.6	29.6	
Varget			24.4	25.3	26.3	27.4		
CFE 223			25.4	26.5	27.7	29.0		
Power Pro 2000 MR			25.8	27.0	28.2	29.3		
AR Comp				23.6	24.9			
Energy Ft. Lbs		900	971	1044	1120	1199	1280	1364
Special Load	Powder	Grains	Velocity fps	Energy Ft. lbs				
Accuracy Load	Power Pro 2000 MR	29.3	3100	1280				
Hunting Load	RE 15	29.6	3200	1364				

22 NOSLER





Bullet	Caliber	Weight	Type	C.O.A.L.
	#1395	.224"	65gr. SBT	2.260"*
	#1380	.224"	69gr. HPBT Match	2.260"*
	#7169	.224"	69gr. TMK Match	2.260"*
*requires a 1x10" or faster twist				

Powder	Velocity	2500	2600	2700	2800	2900	3000	3100
H4895			22.3	23.4	24.5	25.5	26.5	
IMR 4166 End.	21.8	22.7	23.6	24.5	25.5			
IMR 4064	22.7	23.6	24.5	25.4	26.4			
A 4064	23.0	24.1	25.1	26.0	26.9	27.7		
RE 15	22.6	23.6	24.5	25.5	26.4	27.4	28.3	
Varget		24.0	25.1	26.1	27.1	28.0		
CFE 223		24.1	25.4	26.6	27.7	28.6	29.5	
H380		25.6	26.5	27.6	28.7	29.8	31.0	
Power Pro 2000 MR		25.3	26.4	27.5	28.5	29.4	30.2	
Big Game		25.6	26.7	27.9	29.0	30.1	31.2	
N540		23.9	24.9	25.9	26.8	27.6		
H4350	25.0	26.0	27.0	28.0	29.0	30.0	31.1	
RE 17	25.2	26.2	27.2	28.1	29.0	29.8	30.6	
AR Comp			22.2	23.6	24.9	25.9		
Energy Ft. Lbs	902	975	1052	1131	1214	1299	1387	

Special Load	Powder	Grains	Velocity fps	Energy Ft. lbs
Accuracy Load	Power Pro 2000 MR	30.2	3100	1387
Hunting Load	RE 15	28.3	3100	1387

Sierra does not recommend MatchKing bullets for hunting applications.

ZZ NOSLER

Bullet	Caliber	Weight	Type	C.O.A.L.				
	#9377	.224"	77gr. HPBT Match	2.260"*				
	#9377G	.224"	77gr. HPBT Match Cannelured	2.260"*				
	#7177	.224"	77gr. TMK Match	2.300"*				
	#9390	.224"	80gr. HPBT Match	2.400"*				
*requires a 1x8" or faster twist								
Powder	Velocity	2300	2400	2500	2600	2700	2800	2900
H335			21.7	22.6	23.6	24.5		
H4895					21.4	22.5	23.6	
A 2495			21.4	22.5	23.6	24.6		
IMR 4166 End.		20.3	21.3	22.3	23.3	24.3		
IMR 4064		20.9	21.8	22.7	23.7	24.7		
A 2520				22.9	24.1	25.3	26.4	
RE 15				23.0	24.1	25.1	26.2	
Varget					22.6	23.9	25.3	
CFE 223				23.2	24.3	25.5	26.7	
H380				24.9	27.1	28.7	29.7	
Power Pro 2000 MR					24.9	26.1	27.4	28.6
Big Game				25.1	26.3	27.5	28.7	29.8
N540				23.0	24.0	25.0	26.1	
A 4350				24.6	25.7	26.9	28.2	
H4350				24.6	25.6	26.6	27.7	
RE 16					25.6	26.8	28.0	29.2
RE 17				24.9	25.9	27.0	28.0	29.0
AR Comp					21.8	23.0		
Energy Ft. Lbs		904	985	1068	1156	1246	1340	1438
Special Load	Powder	Grains	Velocity fps	Energy Ft. lbs				
Accuracy Load	Big Game	29.8	2900	1438				

Sierra does not recommend MatchKing bullets for hunting applications.

ZZ NOSLER

Bullet Caliber Weight Type								C.O.A.L.
	#9290	.224"	90gr.	HPBT Match				2.400"*
*requires a 1x6.5" or faster twist **requires a 1x7" twist @2650fps and faster								
Powder v	Velocity >	2150	2250	2350	2450	2550	2650	2700
H4895				20.9	22.0	23.4		
IMR 4166 End.				21.6	22.7	24.0		
IMR 4064				22.0	23.3	24.5		
A 4064	19.7	20.9	22.0	23.1	24.2			
RE 15			22.1	23.4	24.6	25.8		
CFE 223			22.5	23.6	24.8			
H380				25.5	26.9	28.1		
Power Pro 2000 MR			22.8	24.0	25.2	26.5		
Big Game			24.0	25.3	26.5	27.7		
N540		21.4	22.4	23.5	24.6			
IMR 4451 End.			25.0	26.1	27.2			
A 4350			23.1	23.9	25.3	27.1		
H4350			23.3	24.5	25.7	26.9		
RE 16			23.2	24.4	25.7	27.0	27.8	
RE 17			23.8	24.9	26.0	27.1	27.6	
Energy Ft. Lbs		924	1012	1103	1199	1299	1403	1457
Special Load	Powder	Grains	Velocity fps	Energy Ft. lbs				
Accuracy Load	H4350	26.9	2650	1403				
<i>Sierra does not recommend MatchKing bullets for hunting applications.</i>								

22 NOSLER

Bullet		Caliber	Weight	Type	C.O.A.L.				
		#1396	.224"	95gr.	HPBT Match	2.400"*			
*requires a 1x6.5" or faster twist									
Powder	Velocity	2050	2150	2250	2350	2450	2550	2600	
H4895			19.4	20.5	21.6	22.8			
IMR 4166 End.			19.9	20.9	21.9	22.9			
IMR 4064	19.6	20.6	21.6	22.7	23.8				
A 4064		20.4	21.5	22.6	23.8				
RE 15			21.6	22.8	23.9				
Varget		19.8	21.0	22.1	23.2				
CFE 223	20.0	21.2	22.3	23.5	24.8				
H380			23.7	25.0	26.2	27.3			
Power Pro 2000 MR			22.4	23.6	24.7	25.8			
Big Game			23.5	24.8	26.0	27.1			
N540		20.5	21.6	22.7	23.8				
IMR 4451 End.		22.9	24.0	25.1	26.3				
A 4350			23.1	24.6	26.0	27.3			
H4350			22.8	23.9	25.2	26.4			
RE 16					23.8	25.1	26.5	27.2	
RE 17				23.0	24.1	25.2	26.3	26.9	
Energy Ft. Lbs		886	975	1068	1165	1266	1371	1426	
Special Load	Powder	Grains	Velocity	fps		Energy	Ft. lbs		
Accuracy Load	H4895	22.8	2450			1266			
<i>Sierra does not recommend MatchKing bullets for hunting applications.</i>									