

22-6mm (224 TTH)**Test Specifications:**

Firearm Used: Savage 116 FSS

Barrel Length: 26"

Twist: 1 x 8"

Components:

Case: Winchester

Trim-to Length: 2.223"

Primer: Rem 9 1/2

Remarks:



The 224 Texas Trophy Hunter has been a serious long-range varmint and deer hunting round for many years. In the late 1990's, a gun writer by the name of Ralph Lermayer managed to bring the wildcat to the fore-front. The trend was set for the next several years as the ultimate long range hunting cartridge.

The cartridge uses the 6mm Remington case as the parent case. The only change being the neck brought down to the .224 diameter. The main purpose was to generate very high velocities with heavy .22 caliber projectiles. The velocity potential easily surpassed the .22-250 Remington and 220 Swift. These two cartridges with fast twist barrels certainly are no slouches in their own right, but the 22-6mm was just generating more horse-power.

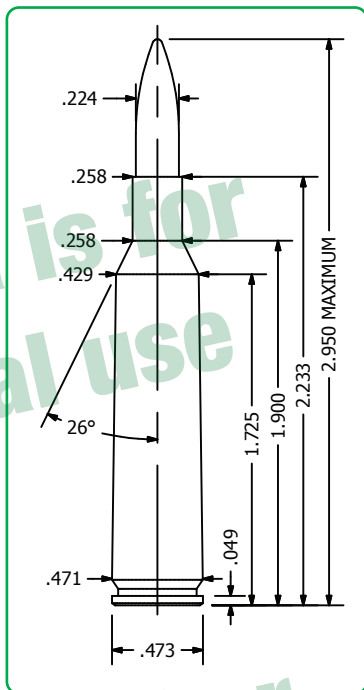
An excellent cartridge for extreme range varmints and predators. Very efficient deer and antelope round in the hands of an experienced and capable shooter. Very easy case-forming and no special firearm requirements make the 22-6mm/224 TTH an easy choice for a wildcat build. Plus performance to spare.





22-6mm (224 TTH)







		Bullet	Caliber	Weight	Type					C.O.A.L.
		#1385	.224"	40gr.	HP					2.640"
		#1440	.224"	40gr.	BlitzKing					2.690"
Powder	Velocity	4000	4050	4100	4150	4200	4250	4300		
RE-15		42.8	43.2	43.6	44.0					
Viht N550		46.1	46.5	46.9	47.3	47.7	48.1	48.5		
A 4350		48.8	49.3							
IMR-4350		48.6	49.0	49.4	49.8	50.2				
H4350		48.8	49.3	49.8	50.3					
RE-19		51.4	52.0							
Viht N160		49.2	49.7	50.2	50.7	51.2	51.7			
IMR-4831		50.4	51.0							
Energy Ft. Lbs		1421	1457	1493	1530	1567	1604	1642		
Special Load	Powder	Grains	Velocity fps	Energy Ft. lbs						
Accuracy Load	H4350	50.3	4150	1530						
Hunting Load	Viht N550	48.5	4300	1642						

Do not edit or redistribute.

22-6mm (224 TTH)

	Bullet	Caliber	Weight	Type	C.O.A.L.			
	#1320	.224"	50gr.	SMP	2.720"			
	#1330	.224"	50gr.	SPT	2.750"			
	#1450	.224"	50gr.	BlitzKing	2.750"			
Powder	Velocity	3800	3850	3900	3950	4000	4050	4100
RE-15		42.2	42.8	43.4				
Viht N550		43.9	44.4	44.8	45.3	45.7	46.2	46.6
A 4350		46.4	46.9	47.3	47.8	48.2		
IMR-4350		47.0	47.5	47.9	48.4	48.8	49.3	49.7
H4350		46.8	47.3	47.8	48.3	48.8	49.3	49.8
RE-19		48.6	49.2	49.7	50.3	50.8		
Viht N160		46.5	47.1	47.7	48.3	48.9	49.5	50.1
IMR-4831		47.8	48.4	48.9	49.5			
H4831 SC		50.2	50.9	51.6				
Energy Ft. Lbs		1603	1646	1689	1732	1776	1821	1866
Special Load	Powder	Grains	Velocity fps	Energy Ft. lbs				
Accuracy Load	H4350	48.8	4000	1776				
Hunting Load	Viht N550	46.6	4100	1866				

22-6mm (.224 TTH)



	Bullet	Caliber	Weight	Type	C.O.A.L.
	#1350	.224"	55gr.	SMP	2.695"
	#1355	.224"	55gr.	FMJBT	2.725"
	#1360	.224"	55gr.	SPT	2.750"
	#1365	.224"	55gr.	SBT	2.750"
	#1390	.224"	55gr.	HPBT	2.695"
	#1455	.224"	55gr.	BlitzKing	2.750"*

*requires a 1x12" or faster twist



Powder ▾	Velocity >	3700	3750	3800	3850	3900	3950	4000	4050
760		44.4	45.0	45.6	46.2	46.8	47.4	48.0	
Viht N550		42.9	43.4	43.9	44.4	44.9	45.4	45.9	46.4
A 4350		45.6	46.1	46.6	47.1	47.6			
IMR-4350		45.2	45.7	46.2	46.7	47.2	47.7	48.2	48.7
H4350		45.3	45.9	46.5	47.1	47.7	48.3	48.9	49.5
RE-19		47.2	47.8	48.3	48.9	49.4	50.0	50.5	
Viht N160		45.5	46.1	46.7	47.3	47.9	48.5		
IMR-4831		46.9	47.4	47.9	48.4	48.9			
H4831 SC		49.4	50.0	50.5					
Energy Ft. Lbs		1672	1717	1763	1810	1858	1905	1954	2003

Special Load	Powder	Grains	Velocity fps	Energy Ft. lbs
Accuracy Load	H4350	48.9	4000	1954
Hunting Load	IMR-4350	48.7	4050	2003



22-6mm (224 TTH)

Bullet Caliber Weight Type		C.O.A.L.						
	#1375 .224" 60gr. HP	2.725"						
	#7160 .224" 60gr. TMK	2.725"*						
	#1370 .224" 63gr. SMP	2.725"						
*requires a 1x10" or faster twist								
Powder ▾	Velocity >	3500	3550	3600	3650	3700	3750	3800
760		42.0	42.8	43.6	44.4			
A 4350		42.5	43.2	43.9	44.6	45.3		
IMR-4350		42.9	43.5	44.0	44.6	45.1	45.7	46.2
H4350		41.5	42.3	43.1	43.9	44.7	45.5	
RE-19		43.8	44.6	45.4	46.2	47.0		
Viht N160		41.5	42.2	42.9	43.6	44.3		
IMR-4831		43.3	44.0	44.6	45.3	45.9	46.6	
H4831 SC		45.4	46.4					
RE-22		44.6	45.4	46.2	47.0			
Energy Ft. Lbs		1714	1763	1813	1864	1915	1967	2020
Special Load	Powder	Grains	Velocity fps	Energy Ft. lbs				
Accuracy Load	IMR-4350	45.1	3700	1915				
Hunting Load	IMR-4350	46.2	3800	2020				

22-6mm (224 TTH)

	Bullet	Caliber	Weight	Type	C.O.A.L.			
	#1395	.224"	65gr.	SBT	2.735"*			
	#1380	.224"	69gr.	HPBT MatchKing	2.775"*			
	#7169	.224"	69gr.	TMK Match	2.800"*			
*requires a 1x10" twist								
Powder	Velocity	3300	3350	3400	3450	3500	3550	3600
RE-19		42.5	43.2	43.8	44.5	45.1	45.8	46.4
IMR 4831		42.2	42.8	43.4	44.0	44.6	45.2	45.8
A 3100		43.6	44.2	44.8	45.4	46.0	46.6	47.2
H4831 SC		44.4	44.9	45.4	45.9	46.4	46.9	47.4
Viht N165		43.0	43.8	44.6	45.4	46.2	47.0	47.8
RE-22		43.4	44.2	44.9	45.7	46.4	47.2	48.0
WXR		43.9	44.6	45.3	46.0	46.7	47.4	48.1
IMR-7828		44.8	45.4	45.9	46.5	47.0	47.6	48.1
H1000		47.1	47.7	48.3	48.9	49.5	50.1	50.7
Magnum		48.0	48.6	49.1	49.7	50.2	50.8	51.3
RE-25		46.0	46.8	47.6	48.4	49.2	50.0	50.8
Energy Ft. Lbs		1668	1719	1771	1824	1877	1931	1986
Special Load	Powder	Grains	Velocity fps	Energy Ft. lbs				
Accuracy Load	IMR-7828	48.1	3600	1986				
Hunting Load	Magnum	51.3	3600	1986				
<i>Sierra does not recommend MatchKing bullets for hunting applications</i>								

22-6mm (224 TTH)

	Bullet	Caliber	Weight	Type	C.O.A.L.			
	#9377	.224"	77gr.	HPBT MatchKing	2.850"*			
	#9377G	.224"	77gr.	HPBT Match Cannelured	2.850"*			
	#7177	.224"	77gr.	TMK Match	2.840"*			
*requires a 1x8" or faster twist								
Powder	Velocity	3200	3250	3300	3350	3400	3450	3500
RE-19		40.8	41.5	42.2	42.9	43.6	44.3	45.0
IMR-4831		39.7	40.5	41.3	42.1	42.9	43.7	
A 3100		41.9	42.5	43.1	43.8	44.4	45.1	45.7
H4831 SC		41.6	42.3	43.0	43.7	44.4		
Viht N165		41.5	42.2	42.9	43.6	44.3	45.0	
RE-22		41.3	42.0	42.7	43.4	44.1	44.8	45.5
WXR		42.5	43.1	43.7	44.3	44.9		
IMR-7828		41.6	42.4	43.2	44.0	44.8	45.6	46.4
H1000		45.5	46.4	47.3	48.2			
Magnum		45.7	46.5	47.3	48.1	48.9	49.7	50.5
RE-25		43.4	44.3	45.2	46.1	47.0	47.9	48.8
Energy Ft. Lbs		1751	1806	1862	1919	1976	2035	2094
Special Load	Powder	Grains	Velocity	fps	Energy	Ft. Lbs		
Accuracy Load	Viht N165	45.0	3450		2035			
<i>Sierra does not recommend MatchKing bullets for hunting applications</i>								

22-6mm (224 TTH)

Bullet	Caliber	Weight	Type	C.O.A.L.					
	#9390	.224"	80gr.	HPBT MatchKing	2.900"*				
*requires a 1x8" twist									
Powder	Velocity	3050	3100	3150	3200	3250	3300	3350	
RE-19		39.7	40.5	41.3	42.1	42.9	43.7	44.5	
IMR-4831		39.6	40.3	41.1	41.8	42.6	43.3		
A 3100		40.8	41.5	42.2	42.9	43.6	44.3	45.0	
H4831 SC		41.7	42.5	43.3					
Viht N165		41.4	42.3	43.2	44.1				
RE-22		40.8	41.5	42.2	42.9	43.6	44.3	45.0	
IMR-7828		42.2	42.9	43.6	44.3	45.0	45.7		
H1000		44.5	45.2	45.9	46.6	47.3	48.0		
Magnum			46.7	47.2	47.7	48.2	48.7	49.2	
RE-25		43.1	43.9	44.7	45.5	46.3	47.1	47.9	
Energy Ft. Lbs		1652	1707	1763	1819	1876	1934	1994	
Special Load	Powder	Grains	Velocity	fps		Energy	Ft. lbs		
Accuracy Load	RE-25	47.1	3300			1934			
<i>Sierra does not recommend MatchKing bullets for hunting applications</i>									

Do not edit or redistribute.