

22-250 Remington

Test Specifications:

Firearm Used: Universal

Barrel Length: 24"

Twist: 1-10"

Components:

Case: Winchester

Trim-to Length: 1.900"

Primer: WLR

Remarks:



Many of today's most popular cartridges had their beginnings as wildcats. The 22-250 Remington is one of the best examples. While the 250-3000 Savage case had been necked down to either .22 or .224" caliber by several earlier wildcatters, credit goes to Jerry Gebby for the final version that Remington eventually standardized in 1965. Gebby went so far as to copyright the name "Varminter" in promoting the new cartridge.

Rarely mentioned today is the fact that Gebby actually produced three different Varminter cartridges, each intended for different ranges and performance levels. The cartridge we know today as the 22-250 Remington was known as the 22 Standard Varminter. Gebby also chambered what he called the 22 Senior Varminter, a 257 Roberts necked down to accept .224" diameter bullets. For shorter-range use, Gebby produced the 22 Junior Varminter, a 32-40 Ballard case necked down to .22" caliber. Today, only the 22 Standard Varminter survives. Given the performance of the 22-250, it is difficult to understand why it took so long for a major manufacturer to adopt it. The cartridge had been popular as a benchrest chambering in the game's early days and was very well known and quite popular among varmint hunters.

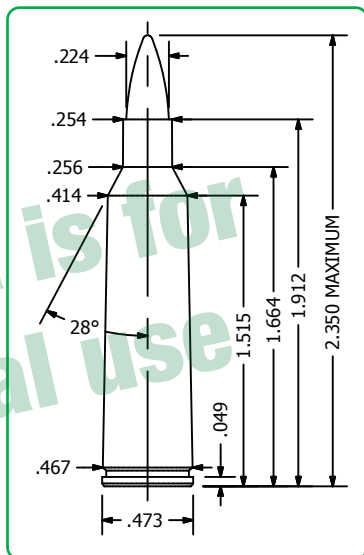
The 22-250 has enjoyed a reputation as an accurate, flat-shooting and hard-hitting varmint cartridge. When loaded to its top velocity levels, the 22-250 is good to 400 yards or better on varmints as large as coyotes. Sierra's line of 22 caliber bullets allows handloaders to optimize performance for their particular shooting situation. Some cautions, however, apply. While we have included data for the 69 grain MatchKing and Tipped MatchKing, these bullets require a rifling twist of 1x10" or faster for proper stabilization. The 77 and 80s need a twist of 1 in 8 for best results. With the addition of the 90 and 95 grain MatchKings, we are now needing a twist rate of 1x6.5". When using 50 and 55 grain Blitz bullets, we recommend that velocities be kept under the 3600 fps level, and twist rates of 1x12" or slower to prevent potential bullet disintegration in flight. The 22-250 Remington is still one of our most popular varmint cartridges and will undoubtedly remain so for many years to come.





7.62x39 Remington

Bullet	Caliber	Weight	Type	C.O.A.L.
	#1385	.224"	40gr. HP	2.350"
	#1440	.224"	40gr. BlitzKing	2.350"





Powder	Velocity	3500	3700	3800	3900	4000	4100	4200
Benchmark		33.0	33.8	34.5	35.3	35.9	36.6	37.2
A 2460			33.1	34.3	35.4	36.4	37.2	37.9
TAC		32.9	33.9	34.9	35.8	36.5	37.3	37.9
IMR 4895		32.6	33.5	34.4	35.2	36.0	36.7	
IMR 4166 End.		32.9	33.7	34.6	35.5	36.5	37.5	
IMR 4064		33.3	34.2	35.1	35.9	36.8	37.6	
Power Pro Varmint		33.6	34.3	35.1	36.0	36.9	37.8	38.9
A 2520		34.2	35.4	36.5	37.5	38.4	39.2	40.0
RE 15		34.2	35.2	36.1	37.0	37.7	38.3	38.8
N140		34.9	35.7	36.5	37.3	38.1	38.8	
Varget			33.3	34.4	35.4	36.5	37.4	38.3
CFE 223		36.4	37.1	37.8	38.6	39.3	40.0	40.7
Power Pro 2000 MR		36.8	37.6	38.5	39.4	40.2	41.1	42.1
Energy Ft. Lbs		1151	1216	1282	1351	1421	1493	1566

Special Load	Powder	Grains	Velocity fps	Energy Ft. lbs
Accuracy Load	Benchmark	37.2	4200	1566
Hunting Load	CFE 223	40.7	4200	1566

22-250 REMINGTON

	Bullet	Caliber	Weight	Type	C.O.A.L.			
	#1210	.224"	45gr.	Hornet	2.350"			
	#1310	.224"	45gr.	SPT	2.350"			
Powder ▾	Velocity >	3500	3600	3700	3800	3900	4000	4100
Benchmark		30.8	31.5	32.3	33.3	34.3	35.5	
A 2460		32.4	33.3	34.2	35.1	36.0	36.9	
TAC		32.3	33.3	34.3	35.3	36.3		
H4895		32.1	32.9	33.8	34.6	35.5	36.3	
IMR 4895		32.3	33.4	34.3	35.2	36.1		
IMR 4166 End.		31.9	33.3	34.5	35.5	36.4		
IMR 4064		33.0	33.8	34.7	35.6	36.6		
Power Pro Varmint		33.2	34.1	35.0	35.9	36.8	37.6	38.5
A 2520		34.2	35.1	36.0	36.9	37.8	38.7	
RE 15		33.8	34.8	35.7	36.5	37.3	38.0	
N140		34.2	35.2	36.1	36.9	37.6		
Varget		32.6	33.3	34.1	35.1	36.1	37.2	
CFE 223		35.5	36.5	37.4	38.2	39.0	39.7	40.3
Power Pro 2000 MR		36.2	37.0	37.9	38.8	39.7	40.6	41.6
Energy Ft. Lbs		1224	1295	1368	1443	1520	1598	1679
Special Load	Powder	Grains	Velocity fps	Energy Ft. lbs				
Accuracy Load	Power Pro 2000 MR	41.6	4100	1679				
Hunting Load	Power Pro Varmint	38.5	4100	1679				

7.62x39 Remington

Bullet	Caliber	Weight	Type	C.O.A.L.
	#1320	.224"	50gr. SMP	2.350"
	#1330	.224"	50gr. SPT	2.350"
	#1340	.224"	50gr. Blitz	2.350"
	#1450	.224"	50gr. BlitzKing	2.350"

Powder	Velocity	3300	3400	3500	3600	3700	3800	3900
Benchmark		29.4	30.3	31.2	32.1	33.1	34.2	
A 2460			31.3	32.2	33.1	34.2	35.4	
TAC			31.2	32.4	33.5	34.6	35.6	
H4895		30.2	31.2	32.2	33.1	34.1	35.0	36.0
IMR 4895		30.7	31.7	32.6	33.6	34.7	35.7	
IMR 4166 End.		30.4	31.2	32.2	33.4	34.7		
IMR 4064			31.3	32.7	33.9	35.1	36.1	
Power Pro Varmint				33.6	34.6	35.6	36.5	37.3
A 2520				33.8	34.9	35.9	37.0	38.0
RE 15	31.4	32.3	33.2	34.1	35.1	36.1	37.0	
N140	32.0	33.1	34.1	35.1	36.0	36.9		
Varget				32.2	33.4	34.6	35.7	36.7
CFE 223			34.1	34.8	35.7	36.6	37.5	38.5
H380					37.2	39.2	40.7	41.7
Power Pro 2000 MR			35.1	36.0	36.9	37.9	38.8	39.8
Big Game					35.8	36.9	38.2	39.5
Energy Ft. Lbs		1209	1283	1360	1439	1520	1603	1688

Special Load	Powder	Grains	Velocity fps	Energy Ft. lbs
Accuracy Load	A 2460	35.4	3800	1603
Hunting Load	H4895	36.0	3900	1688

22-250 REMINGTON

	Bullet	Caliber	Weight	Type	C.O.A.L.
	#1410	.224"	52gr.	HPBT MatchKing	2.350"
	#1400	.224"	53gr.	HP MatchKing	2.350"
	#1345	.224"	55gr.	Blitz	2.350"
	#1350	.224"	55gr.	SMP	2.350"
	#1355	.224"	55gr.	FMJBT	2.350"
	#1360	.224"	55gr.	SPT	2.350"
	#1365	.224"	55gr.	SBT	2.350"
	#1390	.224"	55gr.	HPBT	2.320"
	#1455	.224"	55gr.	BlitzKing	2.350"*



*55gr BlitzKing requires a 1x12" or faster twist

Powder ∨	Velocity >	3200	3300	3400	3500	3600	3700	3800
TAC		30.5	31.7	32.7	33.7	34.5	35.3	
IMR 4166 End.		30.0	31.0	32.1	33.2	34.2	35.3	
IMR 4064		30.8	31.8	32.7	33.7	34.7		
RE 15			31.9	33.1	34.3	35.3	36.3	
N140		31.5	32.8	34.0	35.1	36.1		
Varget		30.4	31.3	32.3	33.4	34.5	35.6	
CFE 223		33.3	34.3	35.2	36.2	37.0	37.8	
H380				35.8	37.1	38.4	39.8	
Power Pro 2000 MR		34.2	35.2	36.2	37.2	38.1	38.9	39.8
Big Game				35.1	36.4	37.7	39.0	
IMR 4350		35.0	36.1	37.2	38.2	39.3		
IMR 4451 End.		34.3	35.6	36.9	38.1	39.3	40.4	
H4350		34.2	35.2	36.3	37.5	38.7	39.9	
RE 16		33.8	34.7	35.7	36.8	37.9		
RE 17		34.1	35.3	36.4	37.4	38.3	39.1	39.8
Energy Ft. Lbs		1182	1257	1335	1414	1496	1580	1667



Special Load	Powder	Grains	Velocity fps	Energy Ft. lbs
Accuracy Load	H380	39.8	3700	1580
Hunting Load	Power Pro 2000 MR	39.8	3800	1667

Sierra does not recommend MatchKing bullets for hunting applications.

22-250 REMINGTON

	Bullet	Caliber	Weight	Type	C.O.A.L.				
	#1375	.224"	60gr.	HP	2.350"				
	#7160	.224"	60gr.	TMK	2.350"*				
	#1370	.224"	63gr.	SMP	2.350"				
*60gr TMK requires a 1x10" or faster twist									
Powder	Velocity	2950	3050	3150	3250	3350	3450	3500	
H4895			28.8	30.1	31.3	32.5	33.7		
IMR 4064	28.5	29.5	30.6	31.7	32.9	34.1			
RE 15				31.2	32.5	33.7	34.9	35.4	
Varget		29.9	31.2	32.4	33.7	34.9			
H380		32.3	33.4	34.6	35.8	37.1	37.8		
Power Pro 2000 MR		32.1	33.3	34.4	35.6	36.8	37.3		
Big Game		32.5	33.6	34.7	35.9	37.1	37.7		
IMR 4350	33.1	34.3	35.5	36.8	38.0				
IMR 4451 End.		34.1	35.3	36.6	37.7	38.8			
A 4350		33.2	34.8	36.3	37.8				
H4350		33.0	34.1	35.3	36.6	38.1	38.9		
RE 16			34.2	35.4	36.7	37.9	38.4		
RE 17			34.0	35.5	36.8	37.9	38.3		
Energy Ft. Lbs		1159	1239	1322	1407	1495	1585	1632	
Special Load	Powder	Grains	Velocity fps	Energy Ft. lbs					
Accuracy Load	Varget	34.9	3450	1585					
Hunting Load	RE 15	35.4	3500	1632					

22-250 REMINGTON

Bullet	Caliber	Weight	Type	C.O.A.L.
	#1395	.224"	65gr. SBT	2.350"*
	#1380	.224"	69gr. HPBT Match	2.350"*
	#7169	.224"	69gr. TMK Match	2.400"*





*requires a 1x10" or faster twist

Powder	Velocity	2900	3000	3100	3200	3300	3400
IMR 4064		29.0	30.1	31.3	32.4		
RE 15			29.9	31.0	32.1	33.3	34.5
Varget		28.5	29.5	30.6	31.7	32.9	
H380		31.1	32.4	33.6	34.9	36.2	37.5
Power Pro 2000 MR		31.6	32.9	34.1	35.2	36.3	37.2
Big Game			32.7	33.8	35.0	36.2	37.6
IMR 4350		32.7	33.7	34.8	36.0	37.2	
IMR 4451 End.		33.0	34.0	35.2	36.3	37.6	
A 4350		32.5	33.9	35.2	36.4	37.6	
H4350			32.3	33.9	35.4	36.6	37.8
RE 16			32.8	33.9	35.0	36.2	37.5
RE 17		31.4	32.6	33.7	34.8	35.9	36.9
RE 19		35.2	36.1	37.1	38.1	39.1	
H4831sc		34.9	36.1	37.5	39.0		
Energy Ft. Lbs		1214	1299	1387	1478	1571	1668

Special Load	Powder	Grains	Velocity fps	Energy Ft. lbs
Accuracy Load	RE 16	37.5	3400	1668
Hunting Load	RE 15	34.5	3400	1668

Sierra does not recommend MatchKing bullets for hunting applications.

22-250 REMINGTON

Bullet	Caliber	Weight	Type	C.O.A.L.
	#9377	.224"	77gr. HPBT Match	2.430"*
	#9377G	.224"	77gr. HPBT Match Cannelured	2.430"*
	#7177	.224"	77gr. TMK Match	2.530"*
	#9390	.224"	80gr. HPBT Match	2.600"*
*requires a 1x8" or faster twist				

Powder	Velocity	2900	3000	3100	3200	3300	3400	3500
IMR 4064			26.2	27.4	28.6	29.9	31.2	
RE 15				27.1	28.4	29.6	30.9	32.2
Varget					27.7	29.4	30.8	
H380		28.1	28.8	29.9	31.2	32.7	34.6	
Power Pro 2000 MR			29.2	30.7	32.1	33.5	35.0	
Big Game				30.5	31.7	32.9	34.3	35.8
IMR 4350	29.2	30.4	31.6	32.8	34.0	35.3		
IMR 4451 End.		30.3	31.6	32.8	34.0	35.1		
A 4350			29.4	30.8	32.3	33.9		
H4350			30.1	31.6	32.9	34.1	35.3	
RE 16					30.2	31.6	33.0	34.4
RE 19				32.4	34.1	35.6	37.0	38.1
H4831sc					34.4	35.9	37.5	
IMR 4955 End.	30.1	31.2	32.4	33.5	34.6	35.7		
N560				33.7	35.1	36.5	37.8	39.2
Energy Ft. Lbs		1156	1246	1340	1438	1539	1643	1750

Special Load	Powder	Grains	Velocity fps	Energy Ft. lbs
Accuracy Load	RE 16	34.4	3500	1750

Sierra does not recommend MatchKing bullets for hunting applications.

22-250 REMINGTON

Bullet		Caliber	Weight	Type	C.O.A.L.			
	#9290	.224"	90gr.	HPBT Match	2.600"*			
		*requires a 1x6.5" or faster twist		**requires a 1x7" twist @2650fps and faster				
Powder	Velocity	2500	2600	2700	2800	2900	3000	3100
IMR 4350		28.7	30.3	31.9	33.4			
IMR 4451 End.			29.1	30.5	32.0			
H4350		28.1	29.8	31.4	33.0			
RE 16				30.5	32.2	33.7		
RE 17			28.8	30.1	31.5	32.8		
Hybrid 100V			28.9	30.1	31.5	33.1		
RE 19			31.4	32.9	34.3	35.8		
H4831sc				31.7	33.6	35.2		
Superformance				32.9	34.6	36.2	37.6	
IMR 4955 End.	28.2	29.7	31.1	32.4	33.6			
RE 22			30.9	32.2	33.7	35.1		
N560			32.1	33.7	35.3	36.7		
IMR 7828ssc		31.7	33.2	34.5	35.8	36.9		
H1000			34.0	35.3	36.8	38.6		
Magnum		35.4	36.6	38.0	39.6			
Energy Ft. Lbs		1249	1351	1457	1566	1680	1798	1920
Special Load	Powder	Grains	Velocity fps	Energy Ft. lbs				
Accuracy Load	N560	36.7	3000	1798				
<i>Sierra does not recommend MatchKing bullets for hunting applications.</i>								

7.62x39 Remington

Bullet	Caliber	Weight	Type	C.O.A.L.						
	#1396	.224"	95gr.	HPBT Match	2.635**					
*requires a 1x6.5" or faster twist										
Powder	Velocity	2450	2550	2650	2750	2850	2950	3000		
IMR 4350			28.7	30.2	31.5	32.6				
IMR 4451 End.		27.0	28.4	29.8	31.1	32.3				
H4350			28.4	30.2	31.7					
RE 16			28.7	30.4	31.8	33.0				
Hybrid 100V		27.4	28.9	30.3	31.7					
RE 19			30.7	32.1	33.6	35.1	35.9			
H4831sc			30.3	32.1	33.7					
Superformance			31.3	32.8	34.3	35.8	36.5			
RE 22			28.9	30.7	32.2	33.6	34.7			
N560			30.7	32.0	33.4	34.8	36.1			
RE 23			29.8	31.4	33.0	34.5				
IMR 7828ssc		30.1	31.3	32.5	33.7	34.9				
H1000			33.1	34.5	36.0	37.6				
RE 26					33.5	35.1	36.6	37.3		
Magnum				36.1	37.9	39.8				
Energy Ft. Lbs		1266	1371	1481	1595	1713	1835	1898		
Special Load	Powder	Grains	Velocity fps	Energy Ft. lbs						
Accuracy Load	IMR 4831	36.6	3050	1653						
<i>Sierra does not recommend MatchKing bullets for hunting applications.</i>										