

6 x 45mm (223 Rem Case)**Test Specifications:**

Firearm Used: Winchester M70

Barrel Length: 24"

Twist: 1 x 9"

Components:

Case: Fed. .223 (reformed)

Trim-to Length: 1.750"

Primer: Fed. 205M

Remarks:

Also known as the 6mm/223 Remington, the 6x45mm is nothing more than the standard 223 Remington case necked up to accept .243" diameter bullets. The 223 has proven itself to be an outstanding varmint cartridge, and the 6x45mm is just more of a good thing. Offering nearly the same velocities with somewhat heavier bullets, the 6x45mm gives a bit more wallop than its parent 223 at almost all ranges. This makes the 6x45mm better for tougher varmints, such as badgers and coyotes.



It has been offered as a factory chambering by both Kimber and Cooper Arms, but no commercial maker has ever produced loaded ammunition. This is almost surprising since the cartridge fills a unique varminting niche. With the standardization of the ballistically similar 6mm PPC and Remington BR cartridges, it seems unlikely that the 6x45mm will ever become a factory offering.

This is an extremely easy cartridge to load for. Case forming is accomplished with no more effort than conventional resizing of fired 223 cases. Special forming dies are not required. We recommend a polished, tapered expander ball and a good neck lubricant, such as graphite or motor mica, to ease the necking process.

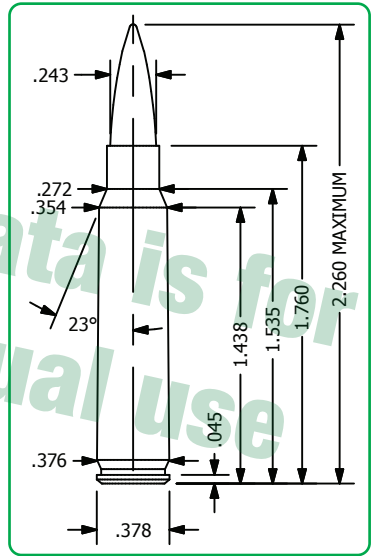
Several powders gave good results in our test rifle. Some of the bulkier powders, such as IMR-3031, will require the use of a drop tube to get the full charge shown into the case. For use on varmints, bullets weighing from 60 to 80 grains will be the best choices. Although deer have been taken with the 6x45mm, its performance is marginal for such game. Heavier bullets, particularly the 85 grain projectiles, are the best options for deer and antelope, but they require precise shot placement. While our test rifle had a twist fast enough to stabilize the 100 grain bullets, they cannot be driven fast enough to assure proper expansion at longer ranges.





6 H 45mm [223 Rem Case]

Bullet	Caliber	Weight	Type	C.O.A.L.
	#1500	.243"	60gr. HP	2.260"
	#1502	.243"	55gr. BlitzKing	2.260"

Powder ∨	Velocity >	2800	2900	3000	3100	3200
IMR-4198		22.0	22.6	23.1		
A 2015 BR		23.3	24.0	24.6	25.3	
IMR-3031		24.4	25.2	26.0		
H322		23.0	23.7	24.3	25.0	25.6
A 2230		24.5	25.3	26.0	26.8	27.5
748		25.6	26.5	27.3	28.2	29.0
H335		23.2	24.4	25.5	26.7	27.8
A 2495 BR		23.7	24.4	25.0	25.7	26.3
H4895		24.7	25.6	26.4	27.3	28.1
Energy Ft. lbs		957	1027	1099	1173	1250



Special Load	Powder	Grains	Velocity fps	Energy Ft. lb
Accuracy Load	748	28.2	3100	1173
Hunting Load	748	28.2	3100	1173

Bullet	Caliber	Weight	Type	C.O.A.L.
	#1505	.243"	70gr. HPBT MatchKing	2.260"
	#1507	.243"	70gr. BlitzKing	2.260"

Powder ∨	Velocity >	2700	2800	2900	3000	3100
IMR-4198		20.8	21.3	21.8	22.3	
A 2015 BR		22.4	23.2	24.0	24.8	
IMR-3031		24.0	24.9	25.7		
H322		22.5	23.3	24.2	25.0	
748		24.0	25.0	26.0	27.0	28.0
H335		24.1	25.0	25.9	26.8	27.7
A 2495 BR		23.6	24.3	25.0	25.7	26.4
H4895		25.0	25.6	26.3	26.9	
Energy Ft. lbs		1133	1218	1307	1399	1493

Special Load	Powder	Grains	Velocity fps	Energy Ft. lb
Accuracy Load	A 2015BR	24.0	2900	1307
Hunting Load	A 2015BR	24.8	3000	1399



6 X 45mm (ZZ3 Rem Case)

	Bullet	Caliber	Weight	Type	C.O.A.L.
	#1510	.243"	75gr.	HP	2.260"
	#7150	.243"	80gr.	SPT	2.260"
	#1515	.243"	80gr.	SBT Blitz	2.260"

Powder ▾	Velocity >	2500	2600	2700	2800	2900
IMR-4198		19.3	20.1	20.9	21.7	
A 2015 BR		21.7	22.4	23.1	23.7	24.4
IMR-3031		23.0	23.8	24.5	25.3	
H322		21.5	22.2	22.9	23.6	24.3
A 2230		22.4	23.3	24.2	25.0	25.9
748		24.7	25.4	26.2	26.9	27.6
H335		22.6	23.5	24.4	25.3	26.2
A 2495 BR		22.4	23.3	24.3	25.2	26.1
H4895			24.0	25.0	26.0	27.0
Energy Ft. lbs		1041	1126	1214	1305	1400

Special Load	Powder	Grains	Velocity fps	Energy Ft. lb
Accuracy Load	748	26.9	2800	1305
Hunting Load	748	27.6	2900	1400

6 X 45MM (223 REM CASE)

	Bullet	Caliber	Weight	Type	C.O.A.L.
	#1530	.243"	85gr.	HPBT	2.260"
	#1520	.243"	85gr.	SPT	2.260"
	#1535	.243"	90gr.	FMJBT	2.260"

Powder	Velocity	2300	2400	2500	2600	2700
IMR-4198		17.3	18.2	19.0		
A 2015 BR		21.4	22.0	22.6	23.2	23.8
IMR-3031		20.5	21.5	22.5	23.5	24.5
H322		20.5	21.3	22.0	22.8	23.5
A 2230		21.9	22.5	23.1	23.7	24.3
748		24.0	24.6	25.2	25.8	26.4
H335		22.0	22.8	23.5	24.3	25.0
A 2495 BR		22.2	22.8	23.5	24.1	24.7
H4895		20.6	22.0	23.4	24.8	
Energy Ft. lbs		998	1087	1179	1276	1376

Special Load	Powder	Grains	Velocity fps	Energy Ft. lb
Accuracy Load	H335	24.3	2600	1276
Hunting Load	H335	24.3	2600	1276